

Robex

145 LCR-9A

With Tier 4 Interim Engine installed

MOVING YOU FURTHER

HYUNDAI HEAVY INDUSTRIES



*Photo may include optional equipment.

 **HYUNDAI**
CONSTRUCTION EQUIPMENT AMERICAS, INC.

PRIDE AT WORK

Hyundai Heavy Industries strives to build state-of-the-art earthmoving equipment to give every operator maximum performance, more precision, versatile machine preferences, and proven quality.

Take pride in your work with Hyundai!



Robex

145 LCR-9A

Machine Walk-Around

Engine Technology

Proven, reliable, fuel efficient, low emission and low noise
Perkins Tier 4 interim & EU stage III B engine

Hydraulic System Improvements

New patented hydraulic control for improved controllability / Improved control valve design for added efficiency and smoother operation / New auto boom and swing priority system for optimum speed / New auto power boost feature for additional power when needed / Improved arm-in and boom-down flow regeneration system for added speed and efficiency

Pump Compartment

Industry-leading, powerful, reliable Kawasaki designed, variable volume in-line axial piston pumps
New compact solenoid block equipped with 4 solenoid valves, 1 EPPR valve, 1 check valve accumulator and pilot filter - controls 2 speed travel, power boost, boom priority, safety lock, arm regeneration

Enhanced Operator Cab

Improved Visibility

Enlarged cab with improved visibility / See-through upper skylight for visibility and ventilation
Larger right-side glass, now one piece, for better right visibility
Safety glass windows on all sides - less expensive than (polycarbonate) and won't scratch or fade
Closeable sunshade for operator convenience / Reduced front window seam for improved operator view

Improved Cab Construction

New steel tube construction for added operator safety, protection and durability
New window open/close mechanism designed with cable and spring lift assist and single latch release

Improved Suspension Seat / Console Assembly

Ergonomic joysticks with auxiliary control buttons for attachment use. Now with new sleek styling
Heated suspension (standard), New joystick consoles

Advanced 7" Color Cluster with Touch Screen

New Color LCD Display with easy to read digital gauges for hydraulic oil temperature, water temperature, and fuel. Simplified design makes adjustment and diagnostics easier. Also, new enhanced features such as rear-view camera are integrated into monitor.

3 power modes : (P) Power, (S) Standard, (E) Economy, 2 work modes : Dig & Attachment, (U) User mode for operator preference

Enhanced self-diagnostic features with GPS download capability

One pump flow or two pump flow for optional attachment is now selectable through the cluster /

New anti-theft system with password capability

Boom speed and arm regeneration are selectable through the monitor.

Auto power boost is now available - selectable (on/off) through the monitor.

Powerful air conditioning and heat with auto climate control

RMS (Remote Management System) works through GPS/satellite technology to ultimately provide better customer service and support.

Undercarriage

Sealed track chain (urethane seals) / Standard track rail guard / Comfortable bolt-on steps

Large upper roller cut-outs for debris clean-out / Tapered side frames for debris clean-out / Grease-type track tensioner

*Photo may include optional equipment.

PRECISION

Innovative hydraulic system technologies make the 9A series excavator fast, smooth and easy to control.



*Photo may include optional equipment.

Computer Aided Power

The engine horsepower and hydraulic horsepower together in unison through the advanced CAPO(Computer Aided Power Optimization) system, flow for the job at hand. Operator can set their own preferences for boom or swing priority, power mode selection and optional work tools at the touch of a button.

The CAPO system also provides complete self diagnostic features and digital gauges for important information like hydraulic oil temperature, water temperatures and fuel level. This system interfaces with multiple sensors placed throughout the hydraulic system as well as the electronically controlled engine to provide the optimum level of engine power and hydraulic flow.

Power Mode

P (Power Max) mode maximizes machine speed and power for mass production.

S (Standard) mode provides a reduced, fixed rpm for optimum performance and improved fuel economy. For maximum fuel savings and improved control, E (Economy) mode provides precise flow and engine power based on load demand. Three unique power modes provide the operator with custom power, speed and fuel economy.

Work Mode

The work mode allows the operator to select single flow attachments like a hydraulic breaker or bi-directional flow attachments like a crusher. Flow settings unique to each attachment can be programmed from within the cluster.

User Mode

Some jobs require more precise machine settings. Using the versatile U (User) mode, the operator can customize engine speed, pump output, idle speed and other machine settings for the job at hand.

Improved Hydraulic System



To achieve optimum precision, Hyundai redesigned the hydraulic system to provide the operator with super fine touch and improved controllability. Improved pump flow control reduces flow when controls are not being used to minimize fuel consumption.

Improved spool valves in the control valve are engineered to provide more precise flow to each function with less effort.

Improved hydraulic valves, precision-designed variable volume piston pumps, fine-touch pilot controls, and enhanced travel functions make any operator running a 9A series look like a smooth operator. Newly improved features

include arm-in and boom-down flow regeneration, improved control valve technology and innovative auto boom and swing priority for optimal performance in any application.



Auto Boom-swing Priority

This smart function automatically and continuously looks the ideal hydraulic flow balance for the boom and swing motions of the machine. The advanced CAPO system monitors the hydraulic system and adjusts its settings to maximize performance and productivity.

PERFORMANCE

9A series is designed for maximum performance to keep the operator working productively.



*Photo may include optional equipment.

Track Rail Guard & Adjusters

Durable track rail guards keep track links in place. Track adjustment is made easy with standard grease cylinder track adjusters and shock absorbing springs.

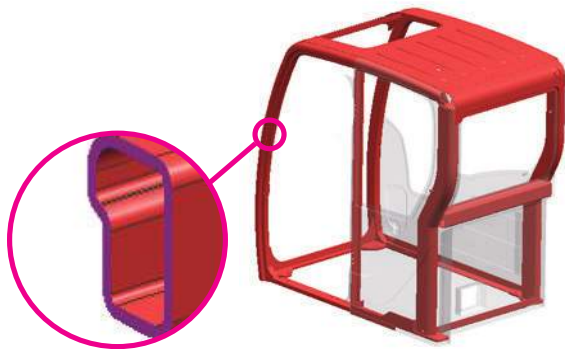

Structure Strength

The 9A series cabin structure has been fitted with stronger but slimmer tubing for more safety and improved visibility. Low-stress, high strength steel is integrally welded to form a stronger, more durable upper and lower frame. Structural integrity was tested by way of FEM (Finite Elements Method) analysis and long-term durability tests.

ROPS (Roll Over Protective Structure) cab can be equipped to enhance operator safety.

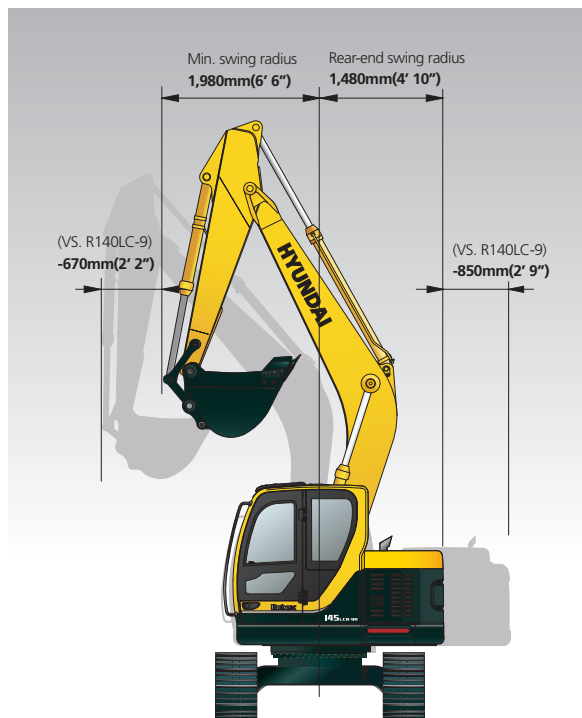

Excellent Performance in Confined Areas

R145LCR-9A's short (1,480mm) tail swing radius allows the operator work in confined areas like close to buildings on roadways, and in urban areas. This Compact radius design provides easy and efficient operation in any limited space work environment.

Perkins 1204E Engine

Tier 4 interim, four cylinder, 4 cycle, turbo-charged, charge air cooled Perkins 1204E engine provides maximum power, reliability, optimum fuel economy, and reduced emissions. Electronically controlled fuel injection and diagnostic capabilities add to the engines efficiency and serviceability.

Better Performance

Using DPF (Diesel Particulate Filter) enables uncompromised, fuel economy and reduced cooling pack size, because the engine calibration does not solely need to be focussed on low particulates. By using mainly passive regeneration and low back pressure aftertreatment designs fuel economy is not negatively impacted.

Integrated aftertreatment without operating impact

The 1204E engines have fully transparent regeneration strategies and service free DPF, completely seamless to the operator.

One solution for all regions

Area mandating the use of DPF are increasing and european air quality directive will drive more non-attainment zones. Because our products use DPFs, our customers don't have to offer a retrofit DPF option to allow machines to operate in these territories.

PREFERENCE

Operating a 9A series is unique to every operator. Operators can fully customize their work environment and operating preferences to fit their individual needs.



*Photo may include optional equipment.



Wide Cabin with Excellent Visibility

The newly designed cabin was conceived for more space, a wider field of view and operator comfort. Special attention was given to a clear, open and convenient interior with plenty of visibility on the machine surroundings and the job at hand. This well balanced combination of precision aspects put the operator in the perfect position to work safely and securely.

Operator Comfort

In the 9A series cabin you can easily adjust the seat, console and armrest settings to best suit your personal operating preferences. Seat and console position can be set together and independent from each other. Additional creature comforts include the fully automatic high-capacity airconditioning system and the radio / USB player.



Reduced Stress

Work is stressful enough. Your work environment should be stress free. Hyundai's 9A series provides improved cab amenities, additional space and a comfortable seat to minimize stress to the operator. A powerful climate control system provides the operator with optimum air temperature. An advanced audio system with USB player, AM/FM stereo and MP3 capabilities, plus remotely located controls is perfect for listening to music favorites.

Operators can even talk on the phone with the hands-free cell phone feature. Also, the newly designed optional remote control offers mobile bluetooth-handsfree and radio cable-handsfree function.



Smart Key System (Option)

9A series excavators provide smart key system as an option. This allows the operator to start the engine by the push of a starter button without inserting a key in the ignition.



Operator - Friendly Cluster

The advanced new cluster with 7 inch wide color LCD with touch screen and toggle switch allows the operator to select his personal machine preferences. Power and work mode selection, self diagnostics, optional rear-view camera, maintenance check lists, start-up machine security, and video functions were integrated into the cluster to make the machine more versatile and the operator more productive.

The newly applied FM transmitter application transmits signal to USB & Radio player with the same frequency as cluster. The player outputs the audio through the internal speaker in the cab. The video & firmware updates are possible with USB host support and an adjustable cluster hinge bracket improves cluster visibility.

Monitor Tilt Range



Horizontal
Total : 15°



Vertical
Total : 30°



PROFITABILITY

9A series is designed to maximize profitability through improved efficiencies, enhanced service features and longer life components.



*Photo may include optional equipment.

Fuel Efficiency

9A series excavators are engineered to be extremely fuel efficient. New innovations like two-stage auto decel system and the new economy mode help to conserve fuel and reduce the impact on the environment.



Hi-mate (Remote Management System)

Hi-mate, Hyundai's proprietary remote management system, provides operators and dealer service personnel access to vital service and diagnostic information on the machine from any computer with internet access. Users can pinpoint machine location using digital mapping and set machine work boundaries, reducing the need for multiple service calls. Hi-mate saves time and money for the owner and dealer by promoting preventative maintenance and reducing machine downtime.



Easy Access

Ground-line access to filters, lube fittings, fuses, machine computer components and wide open compartments makes service more convenient on the 9 series.



Long-Life Components

9A series excavators were designed with bushings designed for long-life lube intervals (250 hrs) & polymer shims (wear resistant, noise reducing), long-life hydraulic filters (1,000hrs), long-life hydraulic oil (5,000hrs), more efficient cooling systems and integrated preheating systems which extend service intervals, minimize operating costs and reduce machine down time.

Specifications

ENGINE

MODEL	Perkins 1204E		
Type	Water cooled, 4 cycle Diesel, 4-cylinders in line, direct injection, turbocharged charger and air cooled		
Rated flywheel horse power	SAE	J1995 (gross)	124 HP (92.7 kW) / 1,950 rpm
		J1349 (net)	116 HP (87 kW) / 1,950 rpm
	DIN	6271/1 (gross)	126 PS (92.7 kW) / 1,950 rpm
		6271/1 (net)	118 PS (87 kW) / 1,950 rpm
Max. torque	54.0 kgf-m(391 lbf-ft)/ 1,400 rpm		
Bore X stroke	105 x 127 mm (4.1" x 5.0")		
Piston displacement	4,400cc (268.5 in ³)		
Batteries	2 X 12V X 100AH		
Starting motor	24V- 4.5kW		
Alternator	24V- 85Amp		

HYDRAULIC SYSTEM

MAIN PUMP	
Type	Variable displacement tandem axis piston pumps
Rated flow	2 X 123.5L /min (32.6 US gpm / 27.2 UK gpm)
Sub-pump for pilot circuit	Gear pump
Cross-sensing and fuel saving pump system.	

HYDRAULIC MOTORS	
Travel	Two speed axial pistons motor with brake valve and parking brake
Swing	Axial piston motor with automatic brake

RELIEF VALVE SETTING	
Implement circuits	350 kgf/cm ² (4,980 psi)
Travel	350 kgf/cm ² (4,980 psi)
Power boost (boom, arm, bucket)	380 kgf/cm ² (5,410 psi)
Swing circuit	285 kgf/cm ² (4,050 psi)
Pilot circuit	40 kgf/cm ² (570 psi)
Service valve	Installed

HYDRAULIC CYLINDERS	
No. of cylinder bore X stroke	Boom: 2-105 X 1,105 mm (4.1" X 43.5")
	Arm: 1-115 X 1,138 mm (4.5" X 44.8")
	Bucket: 1-100 X 840 mm (3.9" X 33.1")
	Blade: 2-100 X 250 mm (3.9" X 9.8")
	2 pcs Boom

DRIVES & BRAKES

Drive method	Fully hydrostatic type
Drive motor	Axial piston motor, in-shoe design
Reduction system	Planetary reduction gear
Max. drawbar pull	13,300 kgf (29,321 lbf)
Max. travel speed(high) / (low)	5.5 km/hr (3.4 mph) / 3.3 km/hr (2.1 mph)
Gradeability	35 ⁰ (70 %)
Parking brake	Multi wet disc

CONTROL

Pilot pressure operated joysticks and pedals with detachable lever provide almost effortless and fatigueless operation.

Pilot control	Two joysticks with one safety lever (LH): Swing and arm, (RH): Boom and bucket(ISO)
Traveling and steering	Two levers with pedals
Engine throttle	Electric, Dial type

SWING SYSTEM

Swing motor	Fixed displacement axial piston motor
Swing reduction	Planetary gear reduction
Swing bearing lubrication	Grease-bathed
Swing brake	Multi wet disc
Swing speed	11.5 rpm

COOLANT & LUBRICANT CAPACITY

Refilling	liter	US gal	UK gal
Fuel tank	232	61.3	51.0
Engine coolant	14.5	2.8	2.3
Engine oil	10.5	4.6	3.8
Swing device-gear oil	2.5	0.7	0.5
Final drive(each)-gear oil	2.2	0.6	0.5
Hydraulic system(including tank)	180	47.6	39.6
Hydraulic tank	96	25.4	21.1

UNDERCARRIAGE

The X-leg type center frame is integrally welded with reinforced box-section track frames. The undercarriage includes lubricated rollers, idlers, track adjusters with shock absorbing springs and sprockets, and a track chain with double or triple grouser shoes.

Center frame	X - leg type			
Track frame	Pentagonal box type			
No. of shoes on each side	R145CR-9A	45EA	R145LCR-9A	47EA
No. of carrier roller on each side		1 EA		2 EA
No. of track roller on each side		7 EA		7 EA
No. of rail guard on each side		2 EA		2 EA

OPERATING WEIGHT (APPROXIMATE)

Operating weight, including 4,600mm (15' 1") boom, 2,500mm (8' 2") arm, SAE heaped 0.52m³ (0.68 yd³) bucket, lubricant, coolant, full fuel tank, full hydraulic tank, and all standard equipments.

MAJOR COMPONENT WEIGHT	
Upperstructure	6,950 kg (15,320 lb)
4.6m (15' 1") mono boom(with arm cylinder)	1,030 kg (2,270 lb)

OPERATING WEIGHT				
Shoes		Operating weight	Ground pressure	
Type	Width mm(in)	kg(lb)	kgf/cm ² (psi)	
Triple grouser	500 (20")	R145CR-9A	14,600(32,190)	0.46(6.54)
		R145CR-9A (Dozer type)	15,400(33,950)	0.49(6.97)
		R145LCR-9A	14,785(32,600)	0.44(6.26)
		R145LCR-9A (Dozer type)	15,585(34,360)	0.47(6.68)
	600 (24")	R145CR-9A	14,790(32,610)	0.39(5.55)
		R145CR-9A (Dozer type)	15,610(34,410)	0.41(5.83)
		R145LCR-9A	14,980(33,020)	0.37(5.26)
		R145LCR-9A (Dozer type)	15,800(34,830)	0.40(5.69)
	700 (28")	R145CR-9A	15,020(33,110)	0.34(4.83)
		R145CR-9A (Dozer type)	15,840(34,920)	0.36(5.12)
		R145LCR-9A	15,215(33,540)	0.33(4.69)
		R145LCR-9A (Dozer type)	16,035(35,350)	0.34(4.83)

BUCKETS

All buckets are welded with high-strength steel.

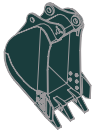

SAE
heaped
m³ (yd³)

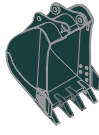

0.23 (0.30)



0.40 (0.52)
0.46 (0.60)

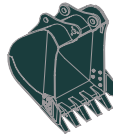

0.52 (0.68)
0.58 (0.76)

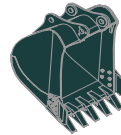

0.65 (0.85)

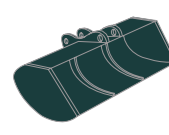

0.71 (0.93)

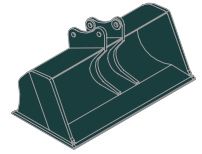

● 0.45 (0.59)

★ 0.55 (0.72)

Capacity m ³ (yd ³)		Width mm (in)		Weight kg (lb)	Recommendation mm (ft-in)			
SAE heaped	CECE heaped	Without sidecutters	With sidecutters		4,600 (15' 1") Boom			
					1,900 (6' 3") Arm	2,100 (6' 11") Arm	2,500 (8' 2") Arm	3,000 (9' 10") Arm
0.23 (0.30)	0.20(0.26)	520(20.5)	620(24.4)	335(740)				■
0.40 (0.52)	0.35(0.46)	760(29.9)	860(33.9)	410(900)				■
0.46 (0.60)	0.40(0.52)	850(33.5)	950(37.4)	435(960)				
0.52 (0.68)	0.45(0.59)	935(36.8)	1,035(40.8)	460(1,010)				-
0.58 (0.76)	0.50(0.65)	1,030(40.6)	1,130(44.5)	480(1,060)			■	-
0.65 (0.85)	0.55(0.72)	1,110(43.7)	1,210(47.6)	500(1,100)	■	■		-
0.71 (0.93)	0.60(0.78)	1,205(47.4)	-	540(1,190)			-	-
● 0.45 (0.59)	0.40(0.52)	1,520(59.8)	-	410(900)			■	-
★ 0.55 (0.72)	0.45(0.59)	1,800(70.9)	-	585(1,290)	■			-

● Ditching bucket

★ Slope finishing bucket

■ : Applicable for materials with density of 2,000 kg /m³ (3,370 lb/ yd³) or less

■ : Applicable for materials with density of 1,600 kg /m³ (2,700 lb/ yd³) or less

■ : Applicable for materials with density of 1,100 kg /m³ (1,850 lb/ yd³) or less

ATTACHMENT

Booms and arms are welded, a low-stress, full-box section design. 4.6m(15' 1") boom and 1.9m(6' 3"), 2.1m(6' 11"), 2.5m(8' 2"), 3.0m(9' 10")arms are available.

DIGGING FORCE

Boom	Length	mm (ft-in)	4,600 (15' 1")				Remarks
	Weight	kg (lb)	1,030 (2,270)				
Arm	Length	mm (ft-in)	1,900 (6' 3")	2,100 (6' 11")	2,500 (8' 2")	3,000 (9' 10")	Power Boost
	Weight	kg (lb)	560 (1,230)	580 (1,280)	610 (1,340)	670 (1,480)	
Bucket digging force	SAE	kN	87.3[94.8]	87.3[94.8]	87.3[94.8]	87.3[94.8]	[]: Power Boost
		kgf	8,900[9,660]	8,900[9,660]	8,900[9,660]	8,900[9,660]	
		lbf	19,620[21,300]	19,620[21,300]	19,620[21,300]	19,620[21,300]	
	ISO	kN	102[110.8]	102[110.8]	102[110.8]	102[110.8]	
		kgf	10,400[11,290]	10,400[11,290]	10,400[11,290]	10,400[11,290]	
		lbf	22,930[24,890]	22,930[24,890]	22,930[24,890]	22,930[24,890]	
Arm crowd force	SAE	kN	76.5[83.1]	73.6[79.9]	62.8[68.2]	55.9[60.7]	[]: Power Boost
		kgf	7,800[8,470]	7,500[8,140]	6,400[6,950]	5,700[6,190]	
		lbf	17,200[18,670]	16,530[17,950]	14,110[15,320]	12,570[13,640]	
	ISO	kN	80.4[87.3]	77.5[84.1]	65.7[71.4]	57.9[62.8]	
		kgf	8,200[8,900]	7,900[8,580]	6,700[7,270]	5,900[6,410]	
		lbf	18,080[19,630]	17,420[18,910]	14,770[16,040]	13,010[14,120]	

Note: Boom weight includes arm cylinder, piping, and pin

Arm weight includes bucket cylinder, linkage, and pin

Dimensions & Working Range

R145LCR-9A DIMENSIONS

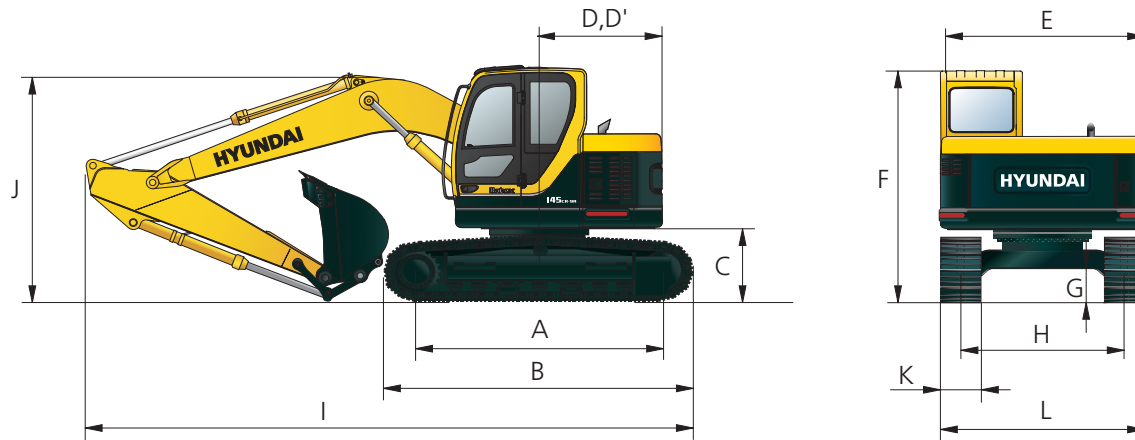

mm (ft-in)

A Tumbler distance	3,090 (10' 2")	Boom length	4,600(15' 1")			
B Overall length of crawler	3,820 (12' 6")	Arm length	1,900 (6' 3")	2,100 (6' 11")	2,500 (8' 2")	3,000 (9' 10")
C Ground clearance of counterweight	930 (3' 1")	I Overall length	7,380 (24' 3")	7,400 (24' 3")	7,360 (24' 2")	7,300 (23' 11")
D Tail swing radius	1,480 (4' 10")	J Overall height of boom	2,630 (8' 8")	2,710 (8' 11")	2,860 (9' 5")	3,210 (10' 6")
D' Rear-end length	1,480 (4' 10")	K Track shoe width	500 (20")	600 (24")	700 (28")	
E Overall width of upperstructure	2,500 (8' 2")	L Overall width	2,500 (8' 2")	2,600 (8' 6")	2,700 (8' 10")	
F Overall height of cab	2,900 (9' 6")					
G Min. ground clearance	440 (1' 5")					
H Track gauge	2,000 (6' 7")					

R145LCR-9A WORKING RANGE

mm (ft-in)

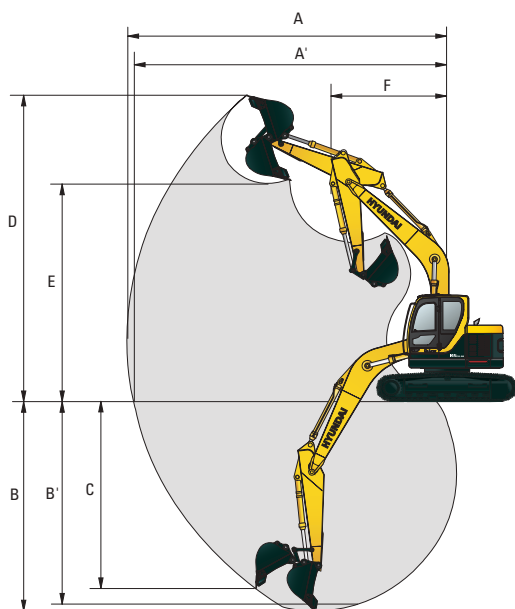

Boom length	4,600(15' 1")			
Arm length	1,900 (6' 3")	2,100 (6' 11")	2,500 (8' 2")	3,000 (9' 10")
A Max. digging reach	7,730 (25' 4")	7,900 (25' 11")	8,310 (27' 3")	8,770 (28' 9")
A' Max. digging reach on ground	7,580 (24' 10")	7,750 (25' 0")	8,170 (26' 10")	8,630 (28' 4")
B Max. digging depth	4,890 (16' 1")	5,100 (16' 9")	5,500 (18' 1")	5,990 (19' 8")
B' Max. digging depth (8' level)	4,640 (15' 3")	4,870 (16' 0")	5,290 (17' 4")	5,810 (19' 1")
C Max. vertical wall digging depth	4,400 (14' 5")	4,600 (15' 1")	5,000 (16' 5")	5,400 (17' 9")
D Max. digging height	8,840 (29' 0")	8,970 (29' 5")	9,350 (30' 8")	9,730 (31' 11")
E Max. dumping height	6,350 (20' 10")	6,470 (21' 3")	6,850 (22' 6")	7,230 (23' 9")
F Min. swing radius	1,860 (6' 1")	2,030 (6' 8")	1,980 (6' 6")	2,260 (7' 5")

Dimensions & Working Range

R145LCR-9A (DOZER TYPE) DIMENSIONS

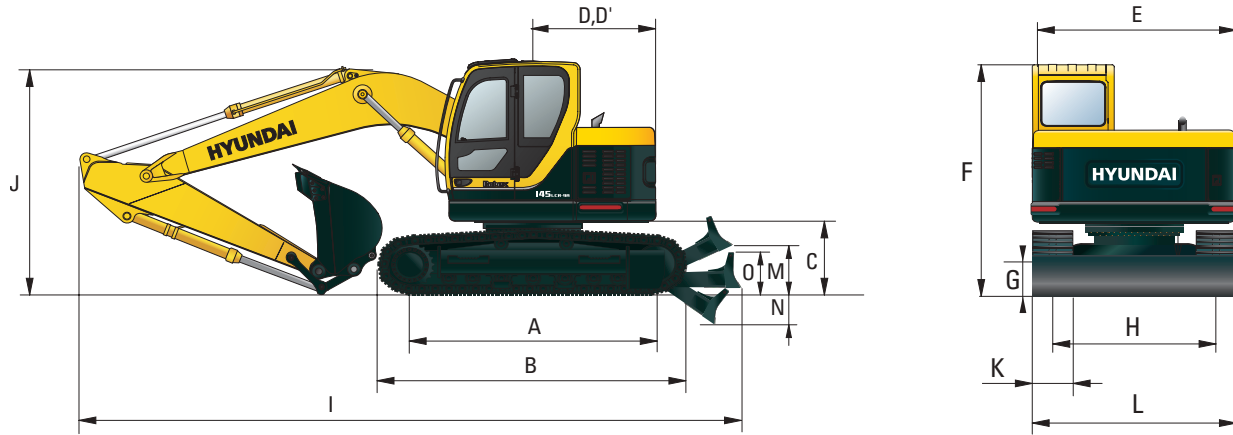

mm (ft-in)

A Tumbler distance	3,090 (10' 2")	Boom length	4,600(15' 1")			
B Overall length of crawler	3,820 (12' 6")	Arm length	1,900 (6' 3")	2,100 (6' 11")	2,500 (8' 2")	3,000 (9' 10")
C Ground clearance of counterweight	930 (3' 1")	I Overall length	7,840 (25' 9")	7,860 (25' 9")	7,820 (25' 8")	7,760 (25' 6")
D Tail swing radius	1,480 (4' 10")	Overall height of boom	2,630 (8' 8")	2,710 (8' 11")	2,860 (9' 5")	3,210 (10' 6")
D' Rear-end length	1,480 (4' 10")	K Track shoe width	500 (20")	600 (24")	700 (28")	
E Overall width of upperstructure	2,500 (8' 2")	L Overall width	2,500 (8' 2")	2,600 (8' 6")	2,700 (8' 10")	
F Overall height of cab	2,900 (9' 6")					
G Min. ground clearance	440 (1' 5")					
H Track gauge	2,000 (6' 7")					
M Ground clearance of blade up	420 (1' 8")					
N Depth of blade down	430 (1' 6")					
O Height of blade	575 (1' 8")					

R145LCR-9A (DOZER TYPE) WORKING RANGE

mm (ft-in)

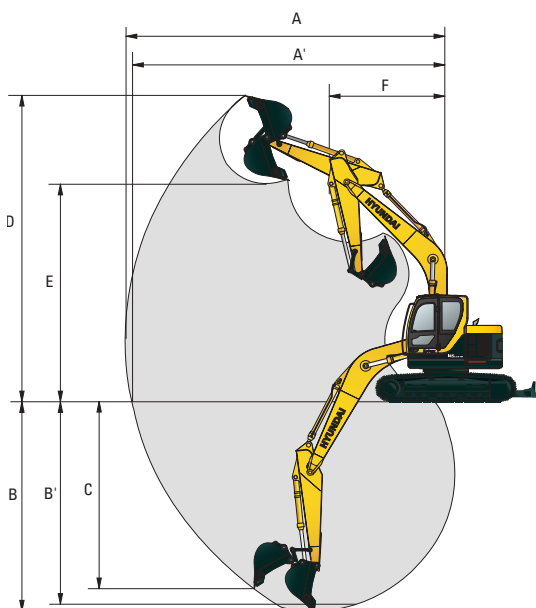

Boom length	4,600(15' 1")			
Arm length	1,900 (6' 3")	2,100 (6' 11")	2,500 (8' 2")	3,000 (9' 10")
A Max. digging reach	7,730 (25' 4")	7,900 (25' 11")	8,310 (27' 3")	8,770 (28' 9")
A' Max. digging reach on ground	7,580 (24' 10")	7,750 (25' 0")	8,170 (26' 10")	8,630 (28' 4")
B Max. digging depth	4,890 (16' 1")	5,100 (16' 9")	5,500 (18' 1")	5,990 (19' 8")
B' Max. digging depth (8' level)	4,640 (15' 3")	4,870 (16' 0")	5,290 (17' 4")	5,810 (19' 1")
C Max. vertical wall digging depth	4,400 (14' 5")	4,600 (15' 1")	5,000 (16' 5")	5,400 (17' 9")
D Max. digging height	8,840 (29' 0")	8,970 (29' 5")	9,350 (30' 8")	9,730 (31' 11")
E Max. dumping height	6,350 (20' 10")	6,470 (21' 3")	6,850 (22' 6")	7,230 (23' 9")
F Min. swing radius	1,860 (6' 1")	2,030 (6' 8")	1,980 (6' 6")	2,260 (7' 5")

Dimensions & Working Range

R145LCR-9A ADJUSTABLE BOOM DIMENSIONS

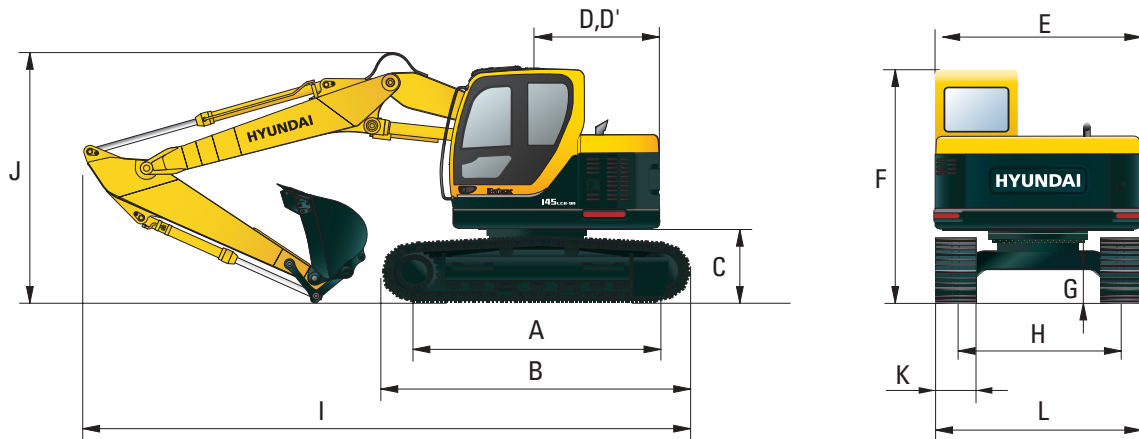

mm (ft-in)

A	Tumbler distance	2,910 (9' 7")	Boom length		4,900(16' 1")		
B	Overall length of crawler	3,640 (11' 11")	Arm length	2,100 (6' 11")	2,500 (8' 2")		
C	Ground clearance of counterweight	930 (3' 1")	I	Overall length	7,720 (25' 4")	7,690 (25' 3")	
D	Tail swing radius	1,480 (4' 10")	J	Overall height of boom	2,870 (9' 5")	2,900 (9' 6")	
D'	Rear-end length	1,480 (4' 10")	K	Track shoe width	500 (20")	600 (24")	700 (28")
E	Overall width of upperstructure	2,500 (8' 2")	L	Overall width	2,500 (8' 2")	2,600 (8' 6")	2,700 (8' 10")
F	Overall height of cab	2,900 (9' 6")					
G	Min. ground clearance	440 (1' 5")					
H	Track gauge	2,000 (6' 7")					

R14LCR-9A ADJUSTABLE BOOM WORKING RANGE

mm (ft-in)

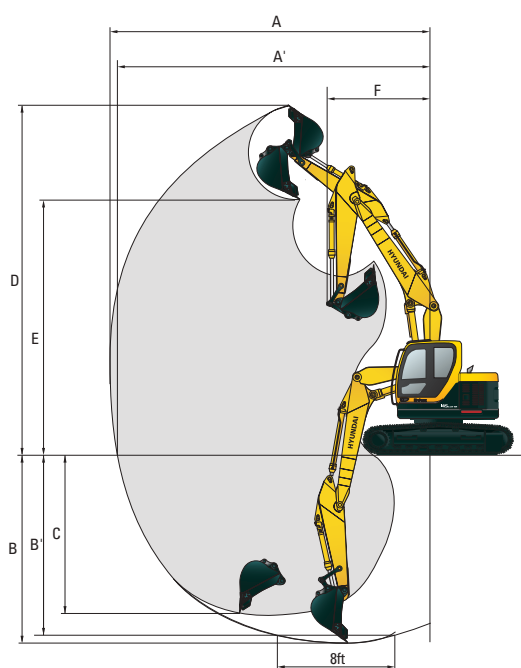

	Boom length	4,900(16' 1")	
	Arm length	2,100 (6' 11")	2,500 (8' 2")
A	Max. digging reach	8,270 (27' 2")	8,675 (28' 6")
A'	Max. digging reach on ground	8,130 (26' 8")	8,540 (28' 0")
B	Max. digging depth	5,175 (16' 12")	5,580 (18' 4")
B'	Max. digging depth (8' level)	5,060 (16' 7")	5,470 (17' 11")
C	Max. vertical wall digging depth	4,555 (14' 11")	5,015 (16' 5")
D	Max. digging height	9,340 (30' 8")	9,715 (31' 10")
E	Max. dumping height	6,850 (22' 6")	7,230 (23' 9")
F	Min. swing radius	2,300 (7' 7")	2,250 (7' 5")

Dimensions & Working Range

R145LCR-9A ADJUSTABLE BOOM (DOZER TYPE) DIMENSIONS

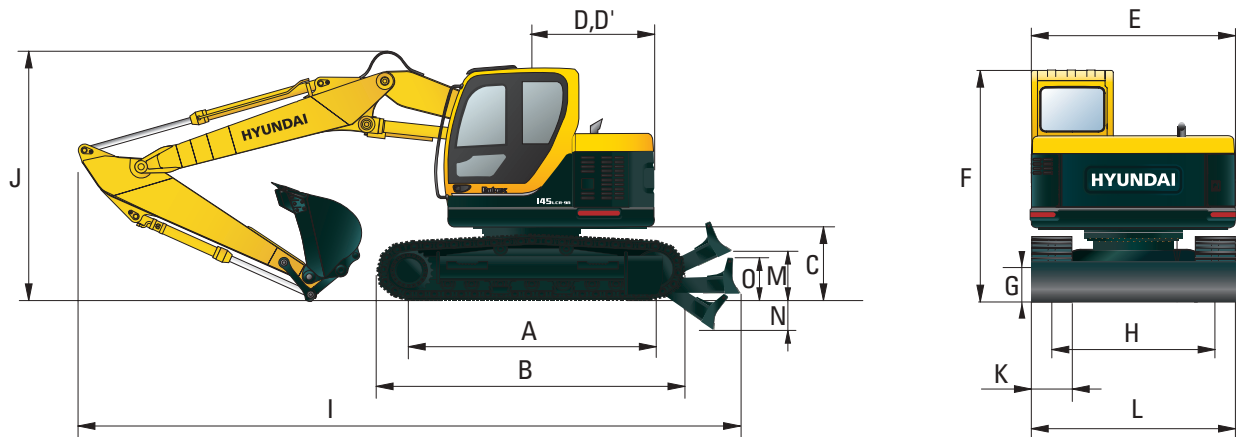

mm (ft-in)

A Tumbler distance	2,910 (9' 7")	Boom length	4,900(16' 1")	
B Overall length of crawler	3,640 (11' 11")	Arm length	2,100 (6' 11")	2,500 (8' 2")
C Ground clearance of counterweight	930 (3' 1")	I Overall length	8,180 (26' 10")	8,150 (26' 9")
D Tail swing radius	1,480 (4' 10")	J Overall height of boom	2,870 (9' 5")	2,900 (9' 6")
D' Rear-end length	1,480 (4' 10")	K Track shoe width	500 (20")	600 (24")
E Overall width of upperstructure	2,500 (8' 2")	L Overall width	2,500 (8' 2")	2,600 (8' 6")
F Overall height of cab	2,900 (9' 6")		700 (28")	2,700 (8' 10")
G Min. ground clearance	440 (1' 5")			
H Track gauge	2,000 (6' 7")			
M Ground clearance of blade up	420 (1' 8")			
N Depth of blade down	430 (1' 6")			
O Height of blade	575 (1' 8")			

R145LCR-9A ADJUSTABLE BOOM WORKING RANGE

mm (ft-in)

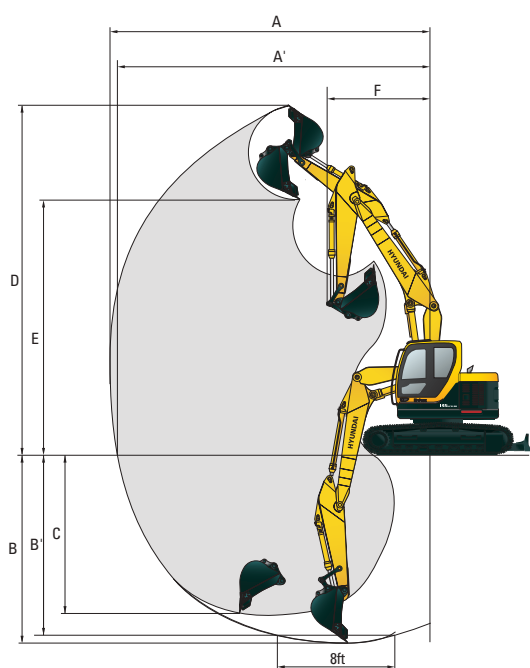











Boom length	4,900(16' 1")	
Arm length	2,100 (6' 11")	2,500 (8' 2")
A Max. digging reach	8,270 (27' 2")	8,675 (28' 6")
A' Max. digging reach on ground	8,130 (26' 8")	8,540 (28' 0")
B Max. digging depth	5,175 (16' 12")	5,580 (18' 4")
B' Max. digging depth (8' level)	5,060 (16' 7")	5,470 (17' 11")
C Max. vertical wall digging depth	4,555 (14' 11")	5,015 (16' 5")
D Max. digging height	9,340 (30' 8")	9,715 (31' 10")
E Max. dumping height	6,850 (22' 6")	7,230 (23' 9")
F Min. swing radius	2,300 (7' 7")	2,250 (7' 5")

Lifting Capacity











R145LCR-9A

 Rating over-front  Rating over-side or 360 degree











Boom : 4.6 m (15' 1") / Arm : 1.9 m (6' 3") / Bucket : 0.52 m³ (0.68 yd³) SAE heaped / Shoe : 500mm(20") triple grouser

Load point height m (ft)	Load radius								At max. reach			
	1.5 m (5 ft)		3.0 m (10 ft)		4.5 m (15 ft)		6.0 m (20 ft)		Capacity		Reach m (ft)	
												
6.0 m (20 ft)	kg					*3270	*3270			3710	2160	5.75
	lb					*7210	*7210			8180	4760	(18.9)
4.5 m (15 ft)	kg			*4960	*4960	*4310	3290			2770	1570	6.73
	lb			*10930	*10930	*9500	7250			6110	3460	(22.1)
3.0 m (10 ft)	kg			*7230	6040	*5000	3090	3310	1870	2410	1330	7.22
	lb			*15940	13320	*11020	6810	7300	4120	5310	2930	(23.7)
1.5 m (5 ft)	kg			*9120	5290	5160	2840	3200	1780	2310	1250	7.32
	lb			*20110	11660	11380	6260	7050	3920	5090	2760	(24.0)
Ground	kg			*8610	5040	4960	2670	3120	1700	2420	1310	7.06
Line	lb			*18980	11110	10930	5890	6880	3750	5340	2890	(23.2)
-1.5 m (-5 ft)	kg	*6830	*6830	*8140	5030	4900	2620			2850	1560	6.40
	lb	*15060	*15060	*17950	11090	10800	5780			6280	3440	(21.0)
-3.0 m (-10 ft)	kg			*6010	5170	*4100	2690			*2250	*2250	5.12
	lb			*13250	11400	*9040	5930			*4960	*4960	(16.8)













Boom : 4.6 m (15' 1") / Arm : 2.1 m (6' 11") / Bucket : 0.52 m³ (0.68 yd³) SAE heaped / Shoe : 500mm(20") triple grouser

Load point height m (ft)	Load radius								At max. reach			
	1.5 m (5 ft)		3.0 m (10 ft)		4.5 m (15 ft)		6.0 m (20 ft)		Capacity		Reach m (ft)	
												
6.0 m (20 ft)	kg					*3440	3370			3490	2030	5.98
	lb					*7580	7430			7690	4480	(19.6)
4.5 m (15 ft)	kg			*4390	*4390	*4140	3310	*2560	1940	2650	1490	6.92
	lb			*9680	*9680	*9130	7300	*5640	4280	5840	3280	(22.7)
3.0 m (10 ft)	kg			*6870	6110	*4840	3100	3310	1880	2310	1260	7.39
	lb			*15150	13470	*10670	6830	7300	4140	5090	2780	(24.2)
1.5 m (5 ft)	kg			*9010	5330	5160	2840	3200	1770	2210	1190	7.49
	lb			*19860	11750	11380	6260	7050	3900	4870	2620	(24.6)
Ground	kg			*8870	5000	4940	2650	3100	1690	2310	1240	7.24
Line	lb			*19550	11020	10890	5840	6830	3730	5090	2730	(23.8)
-1.5 m (-5 ft)	kg	*6560	*6560	*8340	4970	4860	2580	3070	1660	2690	1460	6.60
	lb	*14460	*14460	*18390	10960	10710	5690	6770	3660	5930	3220	(21.7)
-3.0 m (-10 ft)	kg	*9060	*9060	*6360	5090	*4350	2630			*2390	2100	5.38
	lb	*19970	*19970	*14020	11220	*9590	5800			*5270	4630	(17.7)

Boom : 4.6 m (15' 1") / Arm : 2.5 m (8' 2") / Bucket : 0.52 m³ (0.68 yd³) SAE heaped / Shoe : 500mm(20") triple grouser

Load point height m (ft)	Load radius								At max. reach			
	1.5 m (5 ft)		3.0 m (10 ft)		4.5 m (15 ft)		6.0 m (20 ft)		Capacity		Reach m (ft)	
												
6.0 m (20 ft)	kg					*2960	*2960			*2910	1720	6.50
	lb					*6530	*6530			*6420	3790	(21.3)
4.5 m (15 ft)	kg					*3460	3350	*2670	1960	2360	1300	7.37
	lb					*7630	7390	*5890	4320	5200	2870	(24.2)
3.0 m (10 ft)	kg			*6090	*6090	*4480	3130	3320	1880	2080	1110	7.81
	lb			*13430	*13430	*9880	6900	7320	4140	4590	2450	(25.6)
1.5 m (5 ft)	kg			*8480	5450	5180	2850	3190	1760	2000	1050	7.90
	lb			*18700	12020	11420	6280	7030	3880	4410	2310	(25.9)
Ground	kg			*9170	4990	4930	2630	3070	1650	2070	1080	7.67
Line	lb			*20220	11000	10870	5800	6770	3640	4560	2380	(25.2)
-1.5 m (-5 ft)	kg	*5850	*5850	*8700	4890	4810	2530	3020	1600	2370	1260	7.07
	lb	*12900	*12900	*19180	10780	10600	5580	6660	3530	5220	2780	(23.2)
-3.0 m (-10 ft)	kg	*8930	*8930	*7030	4970	*4770	2550			*2400	1730	5.97
	lb	*19690	*19690	*15500	10960	*10520	5620			*5290	3810	(19.6)
-4.5 m (-15 ft)	kg			*3750	*3750							
	lb			*8270	*8270							

Boom : 4.6 m (15' 1") / Arm : 3.0 m (9' 10") / Bucket : 0.52 m³ (0.68 yd³) SAE heaped / Shoe : 500mm(20") triple grouser

Load point height m (ft)	Load radius										At max. reach			
	1.5 m (5 ft)		3.0 m (10 ft)		4.5 m (15 ft)		6.0 m (20 ft)		7.5 m (25 ft)		Capacity		Reach m (ft)	
														
6.0 m (20 ft)	kg					*2560	*2560	*1730	*1730			*2600	1470	7.07
	lb					*5640	*5640	*3810	*3810			*5730	3240	(23.2)
4.5 m (15 ft)	kg					*2760	*2760	*2550	2000			2100	1140	7.86
	lb					*6080	*6080	*5620	4410			4630	2510	(25.8)
3.0 m (10 ft)	kg			*3690	*3690	*3690	3210	*3210	1910	*1430	1200	1880	980	8.27
	lb			*8140	*8140	*8140	7080	*7080	4210	*3150	2650	4140	2160	(27.1)
1.5 m (5 ft)	kg			*7740	5690	*5030	2920	3220	1780	*1990	1150	1800	920	8.36
	lb			*17060	12540	*11090	6440	7100	3920	*4390	2540	3970	2030	(27.4)
Ground	kg			*9190	5090	4970	2670	3080	1660	*1830	1100	1860	950	8.14
Line	lb			*20260	11220	10960	5890	6790	3660	*4030	2430	4100	2090	(26.7)
-1.5 m (-5 ft)	kg	*5380	*5380	*9060	4890	4810	2530	3000	1590			2090	1080	7.59
	lb	*11860	*11860	*19970	10780	10600	5580	6610	3510			4610	2380	(24.9)
-3.0 m (-10 ft)	kg	*7860	*7860	*7790	4900	4780	2500	3000	1590			*2460	1420	6.59
	lb	*17330	*17330	*17170	10800	10540	5510	6610	3510			*5420	3130	(21.6)
-4.5 m (-15 ft)	kg	*8050	*8050	*5160	5080	*3260	2620							
	lb	*17750	*17750	*11380	11200	*7190	5780							











- Lifting capacity is based on SAE J1097, ISO 10567.
- Lifting capacity of the Robex Series does not exceed 75% of the tipping load with the machine on firm, level ground or 87% of full hydraulic capacity.
- The load point is a hook located on the back of the bucket.
- (*) indicates the load limited by hydraulic capacity.

Lifting Capacity











R145LCR-9A (DOZER TYPE)

 Rating over-front  Rating over-side or 360 degree











Boom : 4.6 m (15' 1") / Arm : 1.9 m (6' 3") / Bucket : 0.52 m³ (0.68 yd³) SAE heaped / Shoe : 500mm(20") triple grouser

Load point height m (ft)		Load radius								At max. reach		
		1.5 m (5 ft)		3.0 m (10 ft)		4.5 m (15 ft)		6.0 m (20 ft)		Capacity		Reach m (ft)
												
6.0 m (20 ft)	kg					*3270	*3270			*3720	2300	5.75
	lb					*7210	*7210			*8200	5070	(18.9)
4.5 m (15 ft)	kg			*4960	*4960	*4310	3480			2960	1680	6.73
	lb			*10930	*10930	*9500	7670			6530	3700	(22.1)
3.0 m (10 ft)	kg			*7230	6370	*5000	3280	3530	2000	2580	1430	7.22
	lb			*15940	14040	*11020	7230	7780	4410	5690	3150	(23.7)
1.5 m (5 ft)	kg			*9120	5630	5490	3030	3430	1910	2480	1360	7.32
	lb			*20110	12410	12100	6680	7560	4210	5470	3000	(24.0)
Ground	kg			*8610	5370	5300	2860	3340	1840	2600	1420	7.06
Line	lb			*18980	11840	11680	6310	7360	4060	5730	3130	(23.2)
-1.5 m (-5 ft)	kg	*6830	*6830	*8140	5370	5240	2810			3050	1680	6.40
	lb	*15060	*15060	*17950	11840	11550	6190			6720	3700	(21.0)
-3.0 m (-10 ft)	kg			*6010	5510	*4100	2880			*2250	*2250	5.12
	lb			*13250	12150	*9040	6350			*4960	*4960	(16.8)













Boom : 4.6 m (15' 1") / Arm : 2.1 m (6' 11") / Bucket : 0.52 m³ (0.68 yd³) SAE heaped / Shoe : 500mm(20") triple grouser

Load point height m (ft)		Load radius								At max. reach		
		1.5 m (5 ft)		3.0 m (10 ft)		4.5 m (15 ft)		6.0 m (20 ft)		Capacity		Reach m (ft)
												
6.0 m (20 ft)	kg					*3440	*3440			*3550	2160	5.98
	lb					*7580	*7580			*7830	4760	(19.6)
4.5 m (15 ft)	kg			*4390	*4390	*4140	3500	*2560	2070	2830	1600	6.92
	lb			*9680	*9680	*9130	7720	*5640	4560	6240	3530	(22.7)
3.0 m (10 ft)	kg			*6870	6440	*4840	3290	3530	2010	2480	1370	7.39
	lb			*15150	14200	*10670	7250	7780	4430	5470	3020	(24.2)
1.5 m (5 ft)	kg			*9010	5670	5490	3030	3420	1900	2380	1290	7.49
	lb			*19860	12500	12100	6680	7540	4190	5250	2840	(24.6)
Ground	kg			*8870	5340	5280	2840	3320	1820	2480	1340	7.24
Line	lb			*19550	11770	11640	6260	7320	4010	5470	2950	(23.8)
-1.5 m (-5 ft)	kg	*6560	*6560	*8340	5310	5200	2770	3290	1790	2880	1580	6.60
	lb	*14460	*14460	*18390	11710	11460	6110	7250	3950	6350	3480	(21.7)
-3.0 m (-10 ft)	kg	*9060	*9060	*6360	5430	*4350	2820			*2390	2250	5.38
	lb	*19970	*19970	*14020	11970	*9590	6220			*5270	4960	(17.7)

Boom : 4.6 m (15' 1") / Arm : 2.5 m (8' 2") / Bucket : 0.52 m³ (0.68 yd³) SAE heaped / Shoe : 500mm(20") triple grouser

Load point height m (ft)		Load radius								At max. reach		
		1.5 m (5 ft)		3.0 m (10 ft)		4.5 m (15 ft)		6.0 m (20 ft)		Capacity		Reach m (ft)
												
6.0 m (20 ft)	kg					*2960	*2960			*2910	1840	6.50
	lb					*6530	*6530			*6420	4060	(21.3)
4.5 m (15 ft)	kg					*3460	*3460	*2670	2090	2530	1400	7.37
	lb					*7630	*7630	*5890	4610	5580	3090	(24.2)
3.0 m (10 ft)	kg			*6090	*6090	*4480	3320	3540	2010	2240	1210	7.81
	lb			*13430	*13430	*9880	7320	7800	4430	4940	2670	(25.6)
1.5 m (5 ft)	kg			*8480	5780	*5360	3040	3410	1890	2150	1140	7.90
	lb			*18700	12740	*11820	6700	7520	4170	4740	2510	(25.9)
Ground	kg			*9170	5330	5260	2820	3300	1790	2230	1180	7.67
Line	lb			*20220	11750	11600	6220	7280	3950	4920	2600	(25.2)
-1.5 m (-5 ft)	kg	*5850	*5850	*8700	5230	5150	2720	3240	1740	2550	1370	7.07
	lb	*12900	*12900	*19180	11530	11350	6000	7140	3840	5620	3020	(23.2)
-3.0 m (-10 ft)	kg	*8930	*8930	*7030	5300	*4770	2740			*2400	1860	5.97
	lb	*19690	*19690	*15500	11680	*10520	6040			*5290	4100	(19.6)
-4.5 m (-15 ft)	kg			*3750	*3750							
	lb			*8270	*8270							

Boom : 4.6 m (15' 1") / Arm : 3.0 m (9' 10") / Bucket : 0.52 m³ (0.68 yd³) SAE heaped / Shoe : 500mm(20") triple grouser

Load point height m (ft)		Load radius										At max. reach		
		1.5 m (5 ft)		3.0 m (10 ft)		4.5 m (15 ft)		6.0 m (20 ft)		7.5 m (25 ft)		Capacity		Reach m (ft)
														
6.0 m (20 ft)	kg					*2560	*2560	*1730	*1730			*2600	1580	7.07
	lb					*5640	*5640	*3810	*3810			*5730	3480	(23.2)
4.5 m (15 ft)	kg					*2760	*2760	*2550	2140			2260	1240	7.86
	lb					*6080	*6080	*5620	4720			4980	2730	(25.8)
3.0 m (10 ft)	kg			*3690	*3690	*3690	3400	*3210	2040	*1430	1300	2020	1070	8.27
	lb			*8140	*8140	*8140	7500	*7080	4500	*3150	2870	4450	2360	(27.1)
1.5 m (5 ft)	kg			*7740	6020	*5030	3110	3440	1910	*1990	1250	1950	1010	8.36
	lb			*17060	13270	*11090	6860	7580	4210	*4390	2760	4300	2230	(27.4)
Ground	kg			*9190	5430	5310	2860	3300	1790	*1830	1200	2010	1040	8.14
Line	lb			*20260	11970	11710	6310	7280	3950	*4030	2650	4430	2290	(26.7)
-1.5 m (-5 ft)	kg	*5380	*5380	*9060	5220	5140	2720	3220	1720			2250	1180	7.59
	lb	*11860	*11860	*19970	11510	11330	6000	7100	3790			4960	2600	(24.9)
-3.0 m (-10 ft)	kg	*7860	*7860	*7790	5240	5120	2690	3220	1720			*2460	1540	6.59
	lb	*17330	*17330	*17170	11550	11290	5930	7100	3790			*5420	3400	(21.6)
-4.5 m (-15 ft)	kg	*8050	*8050	*5160	*5160	*3260	2810							
	lb	*17750	*17750	*11380	*11380	*7190	6190							











1. Lifting capacity is based on SAE J1097, ISO 10567.
2. Lifting capacity of the Robex Series does not exceed 75% of the tipping load with the machine on firm, level ground or 87% of full hydraulic capacity.
3. The load point is a hook located on the back of the bucket.
4. (*) indicates the load limited by hydraulic capacity.

Lifting Capacity













R145LCR-9A ADJUSTABLE BOOM

 Rating over-front  Rating over-side or 360 degree

Boom : 4.9 m (16' 1") / Arm : 2.1 m (6' 11") / Bucket : 0.52 m³ (0.68 yd³) SAE heaped / Shoe : 500mm(20") triple grouser

Load point height m (ft)		Load radius								At max. reach		
		1.5 m (5 ft)		3.0 m (10 ft)		4.5 m (15 ft)		6.0 m (20 ft)		Capacity		Reach m (ft)
												
6.0 m (20 ft)	kg	*3440	*3440	*3680	*3680	*3490	3410			3050	1730	6.46
	lb	*7580	*7580	*8110	*8110	*7690	7520			6720	3810	(21.2)
4.5 m (15 ft)	kg	*3330	*3330	*4400	*4400	*3800	3300	*3400	1940	2380	1300	7.33
	lb	*7340	*7340	*9700	*9700	*8380	7280	*7500	4280	5250	2870	(24.0)
3.0m (10 ft)	kg			*6780	5910	*4560	3030	3300	1840	2100	1110	7.77
	lb			*14950	13030	*10050	6680	7280	4060	4630	2450	(25.5)
1.5 m (5 ft)	kg					5080	2740	3170	1720	2010	1050	7.87
	lb					11200	6040	6990	3790	4430	2310	(25.8)
Ground	kg			*5890	4810	4860	2550	3060	1620	2100	1090	7.63
Line	lb			*12990	10600	10710	5620	6750	3570	4630	2400	(25.0)
-1.5 m (-5 ft)	kg			*8270	4820	4790	2490	3020	1590			
	lb			*18230	10630	10560	5490	6660	3510			

Boom : 4.9 m (16' 1") / Arm : 2.5 m (8' 2") / Bucket : 0.52 m³ (0.68 yd³) SAE heaped / Shoe : 500mm(20") triple grouser

Load point height m (ft)		Load radius								At max. reach				
		1.5 m (5.0 ft)		3.0 m (10.0 ft)		4.5 m (15.0 ft)		6.0 m (20.0 ft)		7.5 m (25.0 ft)		Capacity		Reach m (ft)
														
6.0 m (20 ft)	kg	*2580	*2580	*2970	*2970	*3100	*3100	*2050	1970			2660	1480	6.96
	lb	*5690	*5690	*6550	*6550	*6830	*6830	*4520	4340			5860	3260	(22.8)
4.5 m (15.0 ft)	kg	*2210	*2210	*3110	*3110	*3430	3340	*3140	1960			2130	1140	7.77
	lb	*4870	*4870	*6860	*6860	*7560	7360	*6920	4320			4700	2510	(25.5)
3.0m (10.0 ft)	kg			*6010	*6010	*4220	3070	3310	1850			1900	970	8.18
	lb			*13250	*13250	*9300	6770	7300	4080			4190	2140	(26.8)
1.5 m (5.0 ft)	kg			*7630	5190	5110	2760	3160	1710	2150	1110	1820	920	8.27
	lb			*16820	11440	11270	6080	6970	3770	4740	2450	4010	2030	(27.1)
Ground	kg			*6220	4780	4850	2530	3030	1590			1890	950	8.05
Line	lb			*13710	10540	10690	5580	6680	3510			4170	2090	(26.4)
-1.5 m (-5.0 ft)	kg			*8430	4720	4730	2430	2970	1540			2130	1090	7.49
	lb			*18580	10410	10430	5360	6550	3400			4700	2400	(24.6)
-3.0 m (-10.0 ft)	kg					4760	2450							
	lb					10490	5400							











1. Lifting capacity is based on SAE J1097, ISO 10567.
2. Lifting capacity of the Robex Series does not exceed 75% of the tipping load with the machine on firm, level ground or 87% of full hydraulic capacity.
3. The load point is a hook located on the back of the bucket.
4. (*) indicates the load limited by hydraulic capacity.

Lifting Capacity













R145LCR-9A ADJUSTABLE BOOM (DOZER TYPE)

 Rating over-front  Rating over-side or 360 degree

Boom : 4.9 m (16' 1") / Arm : 2.1 m (6' 11") / Bucket : 0.52 m³ (0.68 yd³) SAE heaped / Shoe : 500mm(20") triple grouser

Load point height m (ft)		Load radius								At max. reach		
		1.5 m (5 ft)		3.0 m (10 ft)		4.5 m (15 ft)		6.0 m (20 ft)		Capacity		Reach m (ft)
												
6.0 m (20 ft)	kg	*3440	*3440	*3680	*3680	*3490	*3490			*3150	1860	6.46
	lb	*7580	*7580	*8110	*8110	*7690	*7690			*6940	4100	(21.2)
4.5 m (15 ft)	kg	*3330	*3330	*4400	*4400	*3800	3490	*3400	2070	2620	1410	7.33
	lb	*7340	*7340	*9700	*9700	*8380	7690	*7500	4560	5780	3110	(24.0)
3.0m (10 ft)	kg			*6780	6240	*4560	3220	3610	1980	2320	1210	7.77
	lb			*14950	13760	*10050	7100	7960	4370	5110	2670	(25.5)
1.5 m (5 ft)	kg					*5380	2930	3470	1850	2230	1140	7.87
	lb					*11860	6460	7650	4080	4920	2510	(25.8)
Ground	kg			*5890	5150	5320	2740	3360	1760	2320	1190	7.63
Line	lb			*12990	11350	11730	6040	7410	3880	5110	2620	(25.0)
-1.5 m (-5 ft)	kg			*8270	5160	5250	2680	3320	1720			
	lb			*18230	11380	11570	5910	7320	3790			

Boom : 4.9 m (16' 1") / Arm : 2.5 m (8' 2") / Bucket : 0.52 m³ (0.68 yd³) SAE heaped / Shoe : 500mm(20") triple grouser

Load point height m (ft)		Load radius								At max. reach				
		1.5 m (5.0 ft)		3.0 m (10.0 ft)		4.5 m (15.0 ft)		6.0 m (20.0 ft)		7.5 m (25.0 ft)		Capacity		Reach m (ft)
														
6.0 m (20 ft)	kg	*2580	*2580	*2970	*2970	*3100	*3100	*2050	*2050			*2890	1590	6.96
	lb	*5690	*5690	*6550	*6550	*6830	*6830	*4520	*4520			*6370	3510	(22.8)
4.5 m (15.0 ft)	kg	*2210	*2210	*3110	*3110	*3430	*3430	*3140	2090			2350	1240	7.77
	lb	*4870	*4870	*6860	*6860	*7560	*7560	*6920	4610			5180	2730	(25.5)
3.0m (10.0 ft)	kg			*6010	*6010	*4220	3260	*3450	1980			2100	1070	8.18
	lb			*13250	*13250	*9300	7190	*7610	4370			4630	2360	(26.8)
1.5 m (5.0 ft)	kg			*7630	5520	*5120	2950	3460	1840	*2330	1210	2020	1010	8.27
	lb			*16820	12170	*11290	6500	7630	4060	*5140	2670	4450	2230	(27.1)
Ground	kg			*6220	5120	5300	2720	3330	1730			2090	1040	8.05
Line	lb			*13710	11290	11680	6000	7340	3810			4610	2290	(26.4)
-1.5 m (-5.0 ft)	kg			*8430	5060	5190	2620	3270	1670			2360	1190	7.49
	lb			*18580	11160	11440	5780	7210	3680			5200	2620	(24.6)
-3.0 m (-10.0 ft)	kg					*5000	2640							
	lb					*11020	5820							

- Lifting capacity is based on SAE J1097, ISO 10567.
- Lifting capacity of the Robex Series does not exceed 75% of the tipping load with the machine on firm, level ground or 87% of full hydraulic capacity.
- The load point is a hook located on the back of the bucket.
- (*) indicates the load limited by hydraulic capacity.

Notes



Notes



STANDARD EQUIPMENT

ISO Standard cabin

All-weather steel cab with 360° visibility
 Safety glass windows
 Rise-up type windshield wiper
 Sliding fold-in front window
 Sliding side window(LH)
 Lockable door
 Hot & cool box
 Storage compartment & Ashtray
 Radio & USB player
 Handsfree mobile phone system with USB
 Transparent cabin roof-cover
 12 volt power outlet (24V DC to 12V DC converter)
 Sun visor

Cabin ROPS(ISO 12117-2)

ROPS(Roll over protective structure)

Computer aided power optimization (New CAPO) system

3-power mode, 2-work mode, User mode
 Auto deceleration & one-touch deceleration system
 Auto warm-up system
 Auto overheat prevention system

Automatic climate control

Air conditioner & heater
 Defroster

Self-diagnostics system

Starting Aid (air grid heater) for cold weather

Centralized monitoring

LCD display
 Engine speed or Trip meter/Accel.
 Clock
 Gauges
 Fuel level gauge
 Engine coolant temperature gauge
 Hyd. oil temperature gauge
 Warnings
 Check engine
 Overload
 Communication error
 Low battery
 Air cleaner clogging
 Indicators
 Max power
 Low speed/High speed
 Fuel warmer
 Auto idle

Door and cab locks, one key

Three outside rearview mirrors

Mechanical suspension seat with heater

Pilot-operated slidable joystick

Four front working lights

Electric horn

Batteries (2 x 12V x 100 AH)

Battery master switch

Removable clean-out dust net for cooler

Automatic swing brake

Removable reservoir tank

Fuel pre-filter

Boom holding system

Arm holding system

Track shoes (600mm, 24")

Track rail guard

Accumulator for lowering work equipment

Electric transducer

Lower frame under cover (Normal)

Viscous fan clutch

OPTIONAL EQUIPMENT

Fuel filler pump (35 L/min)

Beacon lamp

Safety lock valve for boom cylinder with overload warning device

Safety lock valve for arm cylinder

Single-acting piping kit (breaker, etc.)

Double-acting piping kit (clamshell, etc.)

Quick coupler

Travel alarm

Booms

4.6 m, 15' 1"

4.9 m, 16' 1" (Hyd. adjustable boom)

Arms

1.9m, 6' 3"

2.1 m, 6' 11"

2.5 m, 8' 2"

3.0 m, 9' 10"

Cabin FOPS/FOG (ISO/DIS 10262) Level II

FOPS (Falling Object Protective Structure)

FOG (Falling Object Guard)

Cabin lights

Cabin front window rain guard

Track shoes

Triple grousers shoe (500mm, 20")

Triple grousers shoe (600mm, 24")

Triple grousers shoe (700mm, 28")

Rubbber pad (600mm, 24")

Lower frame under cover (Additional)

Long crawler lower frame

Dozer blade

Tool kit

Rearview camera

Pattern change valve (2 patterns)

Hi-mate (Remote Management System)

- * Standard and optional equipment may vary. Contact your Hyundai dealer for more information. The machine may vary according to International standards.
- * The photos may include attachments and optional equipment that are not available in your area.
- * Materials and specifications are subject to change without advance notice.
- * All imperial measurements rounded off to the nearest pound or inch.

PLEASE CONTACT



6100 Atlantic Blvd Norcross, GA 30071
 TEL (678) 823 7777 FAX (678) 823 7778