

# Robex 160LC-9A

With Tier 4 Interim Engine installed

MOVING YOU FURTHER

HYUNDAI HEAVY INDUSTRIES



\*Photo may include optional equipment

 **HYUNDAI**  
CONSTRUCTION EQUIPMENT AMERICAS, INC.

# PRIDE AT WORK

Hyundai Heavy Industries strives to build state-of-the-art earthmoving equipment to give every operator maximum performance, more precision, versatile machine preferences, and proven quality.

**Take pride in your work with Hyundai!**



\*Photo may include optional equipment.

# Robex 160LC-9A

## Machine Walk-Around



### Engine Technology

Proven, reliable, fuel efficient, low emission and low noise  
Perkins Tier 4 interim & EU stage III B engine

### Hydraulic System Improvements

New patented hydraulic control for improved controllability / Improved control valve design for added efficiency and smoother operation / New auto boom and swing priority system for optimum speed / New auto power boost feature for additional power when needed / Improved arm-in and boom-down flow regeneration system for added speed and efficiency

### Pump Compartment

Industry-leading, powerful, reliable Kawasaki designed, variable volume in-line axial piston pumps  
New compact solenoid block equipped with 4 solenoid valves, 1 EPPR valve, 1 check valve accumulator and pilot filter - controls 2 speed travel, power boost, boom priority, safety lock, arm regeneration

### Enhanced Operator Cab

#### Improved Visibility

Enlarged cab with improved visibility / See-through upper skylight for visibility and ventilation  
Larger right-side glass, now one piece, for better right visibility  
Safety glass windows on all sides - less expensive than (polycarbonate) and won't scratch or fade  
Closeable sunshade for operator convenience / Reduced front window seam for improved operator view

#### Improved Cab Construction

New steel tube construction for added operator safety, protection and durability  
New window open/close mechanism designed with cable and spring lift assist and single latch release

#### Improved Suspension Seat / Console Assembly

Ergonomic joysticks with auxiliary control buttons for attachment use with new sleek styling  
Heated suspension (standard) or optional air ride suspension with heat  
New joystick consoles - now adjustable in height by pushing the button  
Integrated seat with consoles - reduce the operator fatigue

#### Advanced 7" Color Cluster with Touch Screen

New Color LCD Display with easy to read digital gauges for hydraulic oil temperature, water temperature, and fuel. Simplified design makes adjustment and diagnostics easier. Also, new enhanced features such as rear-view camera are integrated into monitor.

3 power modes : (P) Power, (S) Standard, (E) Economy

2 work modes : Dig & Attachment, (U) User mode for operator preference

Enhanced self-diagnostic features with GPS download capability

One pump flow or two pump flow for optional attachment is now selectable through the cluster

New anti-theft system with password capability

Boom speed and arm regeneration are selectable through the monitor.

Auto power boost is now available - selectable (on/off) through the monitor.

Powerful air conditioning and heat with auto climate control

**RMS** (Remote Management System) works through GPS/satellite technology to ultimately provide better customer service and support.

### Undercarriage

Sealed track chain (urethane seals) / Standard track rail guard / Comfortable bolt-on steps  
Large upper roller cut-outs for debris clean-out / Tapered side frames for debris clean-out / Grease-type track tensioner

# PRECISION

Innovative hydraulic system technologies make the 9A series excavator fast, smooth and easy to control.



\*Photo may include optional equipment.

## Computer Aided Power

The engine horsepower and hydraulic horsepower together in unison through the advanced CAPO (Computer Aided Power Optimization) system, flow for the job at hand. Operator can set their own preferences for boom or swing priority, power mode selection and optional work tools at the touch of a button.

The CAPO system also provides complete self diagnostic features and digital gauges for important information like hydraulic oil temperature, water temperatures and fuel level. This system interfaces with multiple sensors placed throughout the hydraulic system as well as the electronically controlled engine to provide the optimum level of engine power and hydraulic flow.

### Power Mode

P (Power Max) mode maximizes machine speed and power for mass production.

S (Standard) mode provides a reduced, fixed rpm for optimum performance and improved fuel economy. For maximum fuel savings and improved control, E (Economy) mode provides precise flow and engine power based on load demand. Three unique power modes provide the operator with custom power, speed and fuel economy.

### Work Mode

The work mode allows the operator to select single flow attachments like a hydraulic breaker or bi-directional flow attachments like a crusher. Flow settings unique to each attachment can be programmed from within the cluster.

### User Mode

Some jobs require more precise machine settings. Using the versatile U (User) mode, the operator can customize engine speed, pump output, idle speed and other machine settings for the job at hand.

## Improved Hydraulic System



To achieve optimum precision, Hyundai redesigned the hydraulic system to provide the operator with super fine touch and improved controllability. Improved pump flow control reduces flow when controls are not being used to minimize fuel consumption.

Improved spool valves in the control valve are engineered to provide more precise flow to each function with less effort.

Improved hydraulic valves, precision-designed variable volume piston pumps, fine-touch pilot controls, and enhanced travel functions make any operator running a 9A series look like a smooth operator. Newly improved

features include arm-in and boom-down flow regeneration, improved control valve technology and innovative auto boom and swing priority for optimal performance in any application.



## Auto Boom-swing Priority

This smart function automatically and continuously looks the ideal hydraulic flow balance for the boom and swing motions of the machine. The advanced CAPO system monitors the hydraulic system and adjusts its settings to maximize performance and productivity.

# PERFORMANCE

9A series is designed for maximum performance to keep the operator working productively.



\*Photo may include optional equipment.

## Track Rail Guard & Adjusters

Durable track rail guards keep track links in place. Track adjustment is made easy with standard grease cylinder track adjusters and shock absorbing springs.

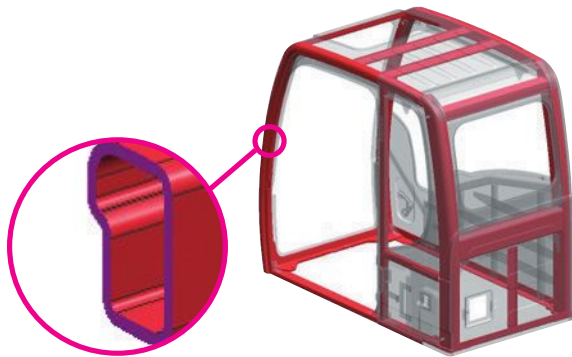

## Structure Strength

The 9A series cabin structure has been fitted with stronger but slimmer tubing for more safety and improved visibility. Low-stress, high strength steel is integrally welded to form a stronger, more durable upper and lower frame. Structural integrity was tested by way of FEM (Finite Elements Method) analysis and long-term durability tests.

The optional ROPS (Roll Over Protective Structure) cab can be equipped to enhance operator safety.



## Perkins 1204E Engine

Tier 4 interim, four cylinder, 4 cycle, turbo-charged, charge air cooled Perkins 1204E engine provides maximum power, reliability, optimum fuel economy, and reduced emissions. Electronically controlled fuel injection and diagnostic capabilities add to the engines efficiency and serviceability.

### Better Performance

Using DPF (Diesel Particulate Filter) enables uncompromised, fuel economy and reduced cooling pack size, because the engine calibration does not solely need to be focused on low particulates. By using mainly passive regeneration and low back pressure aftertreatment designs, fuel economy is not negatively impacted.

### Integrated aftertreatment without operating impact

The 1204E engines have fully transparent regeneration strategies and service free DPF, completely seamless to the operator.

## Easy to maintain engine components

The cooling and preheating system are provided for optimum and immediate operation, guaranteeing longer life for the engine and hydraulic components.

Servicing of the engine and hydraulics is considerably simplified due to total accessibility.

## One solution for all regions

Area mandating the use of DPF are increasing and european air quality directive will drive more non-attainment zones. Because our products use DPFs, our customers don't have to offer a retrofit DPF option to allow machines to operate in these territories.

# PREFERENCE

Operating a 9A series is unique to every operator. Operators can fully customize their work environment and operating preferences to fit their individual needs.



\*Photo may include optional equipment.

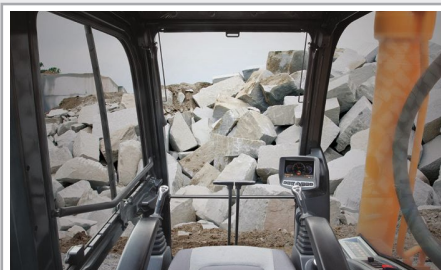

## Wide Cabin with Excellent Visibility

The newly designed cabin has more space, a wider field of view and operator comfort. Special attention was given to a clear, open and convenient interior with plenty of visibility of the machine surroundings and the job at hand. This well balanced combination of comfort and visibility put the operator in the perfect position to work safely and securely.



## Operator Comfort

In 9A series cabin you can easily adjust the seat, console and armrest settings to best suit your comfort level. The seat is integrated with the console so seat suspension absorbs console vibration which reduces operator's fatigue. New joystick consoles are adjustable in height by pushing a button. Other preference settings that add to overall operator comfort include the fully automatic high capacity airconditioning system, transparent polycarbonate glass sun roof, large and easy to control sun visor, and the radio / USB player.



## Reduced Stress

Work is stressful enough. Your work environment should be stress free. Hyundai's 9A series provides improved cab amenities, additional space and a comfortable seat to minimize stress to the operator. A powerful climate control system provides the operator with optimum air temperature. An advanced audio system with USB player, AM/FM stereo and MP3 capabilities, plus remotely located controls is perfect for listening to your favorite music. Operators can talk on the phone with the hands-free cell phone feature. Also, the newly designed optional remote control offers a hands-free mobile bluetooth and hands-free radio cable function.



## Smart Key System (Option)

9A series excavators provide smart key system as an option. This allows the operator to start the engine by the push of a starter button without inserting a key in the ignition.



## Operator - Friendly Cluster

The advanced new cluster with 7-inch wide color LCD touch screen with toggle switches allows the operator to select his personal machine preferences. Power and work mode selection, self diagnostics, optional rear-view camera, maintenance check lists, start-up machine security, and video functions were integrated into the cluster to make the machine more versatile and the operator more productive. The newly applied FM transmitter application transmits signal to USB & radio player with the same frequency as cluster. The player outputs the audio through the internal speaker in the cab. The video & firmware updates are possible with USB host support and an adjustable cluster hinge bracket improves cluster visibility.

## Monitor Tilt Range



**Horizontal**  
Total : 15°



**Vertical**  
Total : 30°



# PROFITABILITY

9A series is designed to maximize profitability through improved efficiencies, enhanced service features and longer life components.



\*Photo may include optional equipment.

## Fuel Efficiency

9A series excavators are engineered to be extremely fuel efficient. New innovations like the variable speed fan clutch, two-stage auto decel system and the new economy mode help to conserve fuel and reduce the impact on the environment.



### Hi-mate (Remote Management System)

Hi-mate, Hyundai's proprietary remote management system, provides operators and dealer service personnel access to vital service and diagnostic information on the machine from any computer with internet access. Users can pinpoint machine location using digital mapping and set machine work boundaries, reducing the need for multiple service calls. Hi-mate saves time and money for the owner and dealer by promoting preventative maintenance and reducing machine downtime.

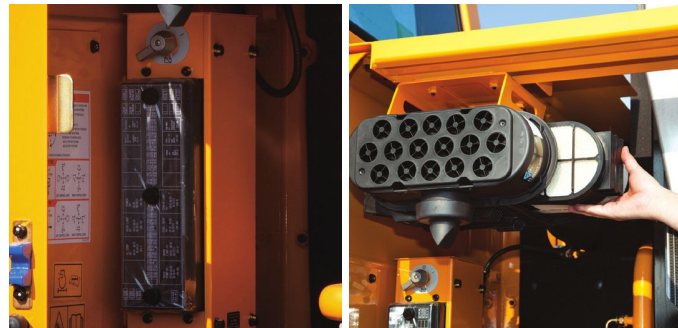
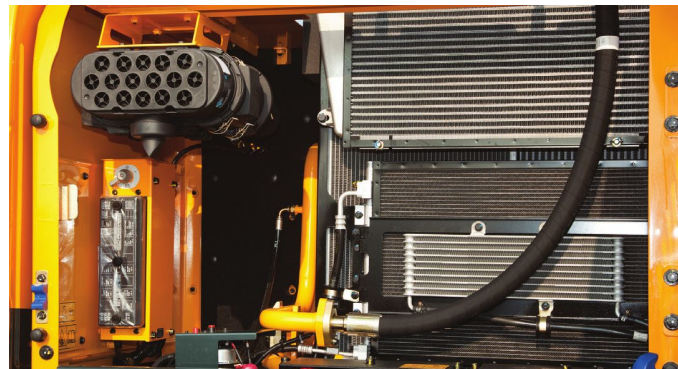

## Easy Access

Ground-line access to filters, lube fittings, fuses, machine computer components and wide open compartments makes service more convenient on the 9A series.



## Long-Life Components

9A series excavators were designed with bushings designed for long-life lube intervals (250hrs) & polymer shims (wear resistant, noise reducing), long-life hydraulic filters (1,000hrs), long-life hydraulic oil (5,000hrs), more efficient cooling systems and integrated preheating systems which extend service intervals, minimize operating costs and reduce machine down time.

# Specifications

## ENGINE

MODEL	Perkins 1204E		
Type	Water cooled, 4 cycle Diesel, 4-cylinders in line, direct injection, turbocharged charger and air cooled		
Rated flywheel horse power	SAE	J1995 (gross)	137 HP (102.2 kW)/ 2,050 rpm
		J1349 (net)	128 HP (96 kW)/ 2,050 rpm
	DIN	6271/1 (gross)	139 PS (102.2 kW)/ 2,050 rpm
		6271/1 (net)	130 PS (96 kW)/ 2,050 rpm
Max. torque	57.1 kgf-m (413 lbf-ft)/ 1,400 rpm		
Bore X stroke	105 x 127 mm (4.13" x 5.0")		
Piston	4,400cc (268.5 in <sup>3</sup> )		
Batteries	2 X 12V X 100AH		
Starting motor	24V- 4.5kW		
Alternator	24V- 85Amp		

## HYDRAULIC SYSTEM

MAIN PUMP	
Type	Variable displacement piston pumps
Rated flow	2 X 164L /min (43.3 US gpm / 36.1 UK gpm)
Sub-pump for pilot circuit	Gear pump
Cross-sensing and fuel saving pump system.	

HYDRAULIC MOTORS	
Travel	Two speed axial pistons motor with brake valve and parking brake
Swing	Axial piston motor with automatic brake

RELIEF VALVE SETTING	
Implement circuits	350 kgf/cm <sup>2</sup> (4,980 psi)
Travel	350 kgf/cm <sup>2</sup> (4,980 psi)
Power boost (boom, arm, bucket)	380 kgf/cm <sup>2</sup> (5,410 psi)
Swing circuit	285 kgf/cm <sup>2</sup> (4,050 psi)
Pilot circuit	40 kgf/cm <sup>2</sup> (570 psi)
Service valve	Installed

HYDRAULIC CYLINDERS	
No. of cylinder bore X stroke	Boom : 2-115 X 1,090 mm (4.5" X 42.9")
	Arm : 1-120 X 1,355 mm (4.7" X 53.3")
	Bucket : 1-110 X 995 mm (4.3" X 39.2")
	Blade : 2-110 X 320 mm (4.3" X 12.6")
	2PCS 1st : 2-115 X 960 mm (4.5" X 37.8")
	2nd : 1-160 X 650 mm (6.3" X 25.6")

## DRIVES & BRAKES

Drive method	Fully hydrostatic type
Drive motor	Axial piston motor, in-shoe design
Reduction system	Planetary reduction gear
Max. drawbar pull	17,000 kgf (37,500 lbf)
Max. travel speed(high) / (low)	5 km/hr (3.1 mph) / 3.2 km/hr (2.0 mph)
Gradeability	30° (58%)
Parking brake	Multi wet disc

## CONTROL

Pilot pressure operated joysticks and pedals with detachable lever provide almost effortless and fatigueless operation.

Pilot control	Two joysticks with one safety lever (LH): Swing and arm, (RH): Boom and bucket (ISO)
Traveling and steering	Two levers with pedals
Engine throttle	Electric, Dial type
Lights	Two lights mounted on the boom Two on the upper frame

## SWING SYSTEM

Swing motor	Two fixed displacement axial pistons motor
Swing reduction	Planetary gear reduction
Swing bearing lubrication	Grease-bathed
Swing brake	Multi wet disc
Swing speed	11.3 rpm

## COOLANT & LUBRICANT CAPACITY

	liter	US gal	UK gal
Refilling			
Fuel tank	270	71.3	59.4
Engine coolant	15.5	4.1	3.4
Engine oil	10.5	2.8	2.3
Swing device-gear oil	5.0	1.3	1.1
Final drive(each)-gear oil	5.8	1.5	1.3
Hydraulic system(including tank)	240	63.4	52.8
Hydraulic tank	160	42.3	35.2

## UNDERCARRIAGE

The X-leg type center frame is integrally welded with reinforced box-section track frames. The undercarriage includes lubricated rollers, idlers, track adjusters with shock absorbing springs and sprockets, and a track chain with double or triple grouser shoes.

Center frame	X - leg type
Track frame	Pentagonal box type
No. of shoes on each side	49
No. of carrier roller on each side	2
No. of track roller on each side	7
No. of rail guard on each side	1

## OPERATING WEIGHT (APPROXIMATE)

Operating weight, including 5,100mm (16' 9") boom, 2,600mm (8' 6") arm, SAE heaped 0.70m<sup>3</sup> (0.92 yd<sup>3</sup>) bucket, lubricant, coolant, full fuel tank, full hydraulic tank, and all standard equipments.

MAJOR COMPONENT WEIGHT	
Upperstructure	4,980 kg (10,980 lb)
5.1m (16' 9") mono boom(with arm cylinder)	1,250 kg (2,760 lb)
Hydraulic adjustable boom(with arm cylinder)	1,780 kg (3,920 lb)

OPERATING WEIGHT				
Shoes		Operating weight		Ground pressure
Type	Width mm(in)		kg (lb)	kgf/cm <sup>2</sup> (psi)
Triple grouser	500 (20")	R160LC-9A	17,550 (38,690)	0.51 (7.25)
		R160LCD-9A	18,550 (40,900)	0.54 (7.68)
	600 (24")	R160LC-9A	17,800 (39,240)	0.43 (6.11)
		R160LCD-9A	18,800 (41,450)	0.46 (6.54)
	700 (28")	R160LC-9A	18,050 (39,790)	0.38 (5.40)
		R160LCD-9A	19,050 (42,000)	0.40 (5.69)



**BUCKETS** All buckets are welded with high-strength steel.

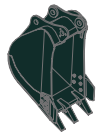

0.39 (0.51)

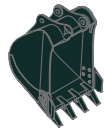

0.50 (0.65)



0.64 (0.84)

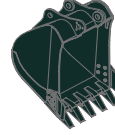

0.70 (0.92)

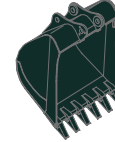

0.89 (1.16)

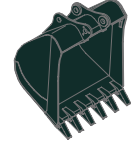

Ⓜ 0.69 (0.90)

SAE heaped m<sup>3</sup> (yd<sup>3</sup>)

Capacity m <sup>3</sup> (yd <sup>3</sup> )		Width mm (in)		Weight kg (lb)	Recommendation mm (ft-in)				
SAE heaped	CECE heaped	Without sidecutters	With sidecutters		5,100 (16' 9") Mono Boom			5,100 (16' 9") Hydraulic Adjustable Boom	
					2,200 (7' 3") Arm	2,600 (8' 6") Arm	3,100 (10' 2") Arm	2,200 (7' 3") Arm	2,600 (8' 6") Arm
0.39 (0.51)	0.34 (0.44)	620 (24.4)	740 (29.1)	410 (900)	●	●	●	●	●
0.50 (0.65)	0.44 (0.58)	760 (29.9)	880 (34.6)	470 (1,040)	●	●	●	●	●
0.64 (0.84)	0.55 (0.72)	920 (36.2)	1,040 (40.9)	510 (1,120)	●	●	■	●	■
0.70 (0.92)	0.60 (0.78)	990 (39.0)	1,110 (43.7)	540 (1,190)	●	■	▲	■	▲
0.89 (1.16)	0.77 (1.01)	1,220 (48.0)	1,340 (52.8)	610 (1,340)	■	▲	-	▲	-
Ⓜ 0.69 (0.90)	0.62 (0.81)	990 (39.0)	-	700 (1,540)	●	■	▲	■	▲

Ⓜ Heavy duty bucket

- : Applicable for materials with density of 2,000 kg /m<sup>3</sup> (3,370 lb/ yd<sup>3</sup>) or less
- : Applicable for materials with density of 1,600 kg /m<sup>3</sup> (2,700 lb/ yd<sup>3</sup>) or less
- ▲ : Applicable for materials with density of 1,100 kg /m<sup>3</sup> (1,850 lb/ yd<sup>3</sup>) or less

**ATTACHMENT**

Booms and arms are welded, a low-stress, full-box section design. 5.1m (16' 9") boom, 5.1m (16' 9") hydraulic adjustable boom and 2.20m (7' 3"), 2.60m (8' 6"), 3.10m (10' 2") arms are available.

**DIGGING FORCE**

Boom	Length	mm (ft-in)	5,100 (16' 9")			Remarks
	Weight	kg (lb)	1,250 (2,760)			
Arm	Length	mm (ft-in)	2,200 (7' 3")	2,600 (8' 6")	3,100 (10' 2")	Remarks
	Weight	kg (lb)	750 (1,560)	810 (1,790)	890 (1,960)	
Bucket digging force	SAE	kN	107.9 [117.2]	107.9 [117.2]	107.9 [117.2]	[ ]: Power Boost
		kgf	11,000 [11,940]	11,000 [11,940]	11,000 [11,940]	
		lbf	24,250 [26,330]	24,250 [26,330]	24,250 [26,330]	
	ISO	kN	123.6 [134.2]	123.6 [134.2]	123.6 [134.2]	
		kgf	12,600 [13,680]	12,600 [13,680]	12,600 [13,680]	
		lbf	27,780 [30,160]	27,780 [30,160]	27,780 [30,160]	
Arm crowd force	SAE	kN	87.2 [94.7]	77.3 [83.9]	69.0 [74.9]	
		kgf	8,890 [9,650]	7,880 [8,560]	7,030 [7,630]	
		lbf	19,600 [21,280]	17,370 [18,860]	15,500 [16,830]	
	ISO	kN	91.0 [98.8]	80.3 [87.2]	71.4 [77.5]	
		kgf	9,280 [10,080]	8,190 [8,890]	7,280 [7,900]	
		lbf	20,460 [22,210]	18,060 [19,600]	16,050 [17,430]	

Note: Boom weight includes arm cylinder, piping, and pin  
 Arm weight includes bucket cylinder, linkage, and pin

# Dimensions & Working Range

## R160LC-9A DIMENSIONS

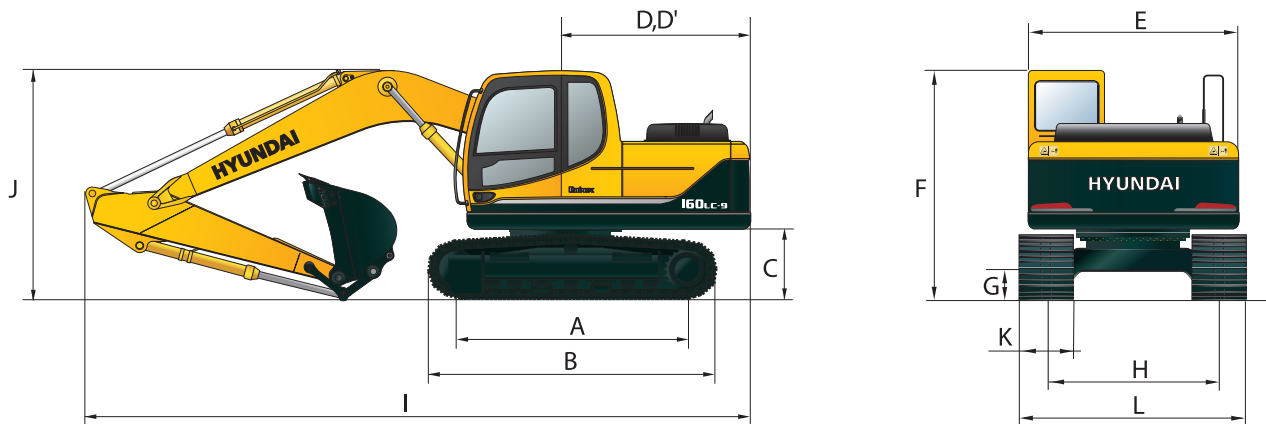

mm (ft-in)

mm (ft-in)

A Tumbler distance	3,170 (10' 5")	Boom length	5,100(16' 9")		
B Overall length of crawler	3,960 (13' 0")	Arm length	2,200 (7' 3")	2,600 (8' 6")	3,100 (10' 2")
C Ground clearance of counterweight	1,055 (3' 6")	I Overall length	8,660 (28' 5")	8,650 (28' 5")	8,650 (28' 5")
D Tail swing radius	2,530 (8' 4")	J Overall height of boom	3,010 (9' 11")	2,990 (9' 10")	3,150 (10' 4")
D' Rear-end length	2,480 (8' 2")	K Track shoe width	500 (20")	600 (24")	700 (28")
E Overall width of upperstructure	2,475 (8' 1")	L Overall width	2,490 (8' 2")	2,590 (8' 6")	2,690 (8' 10")
F Overall height of cab	2,980 (9' 9")				
G Min. ground clearance	460 (1' 6")				
H Track gauge	1,990 (6' 6")				

## R160LC-9A WORKING RANGE

mm (ft-in)

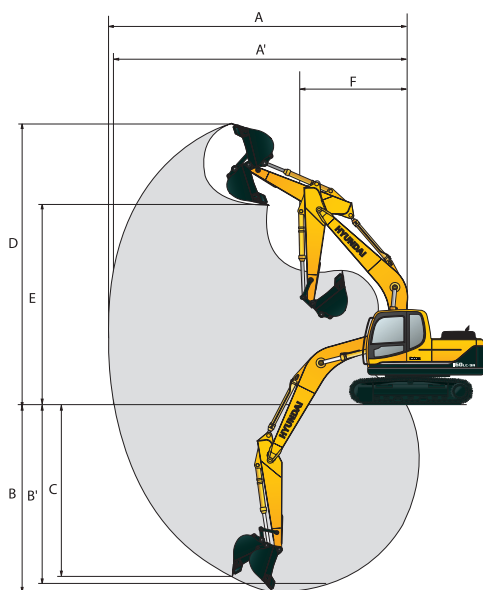

Boom length	5,100 (16' 9")		
Arm length	2,200 (7' 3")	2,600 (8' 6")	3,100 (10' 2")
A Max. digging reach	8,690 (28' 6")	9,020 (29' 7")	9,450 (31' 0")
A' Max. digging reach on ground	8,530 (27' 12")	8,860 (29' 1")	9,300 (30' 6")
B Max. digging depth	5,660 (18' 7")	6,060 (19' 11")	6,560 (21' 6")
B' Max. digging depth (8° level)	5,430 (17' 10")	5,850 (19' 2")	6,370 (20' 11")
C Max. vertical wall digging depth	5,120 (16' 10")	5,380 (17' 8")	5,710 (18' 9")
D Max. digging height	8,750 (28' 8")	8,840 (29' 0")	8,980 (29' 6")
E Max. dumping height	6,110 (20' 1")	6,220 (20' 5")	6,390 (21' 0")
F Min. swing radius	3,180 (10' 5")	3,170 (10' 5")	3,170 (10' 5")

# Dimensions & Working Range

## R160LC-9A 2-PIECE BOOM DIMENSIONS

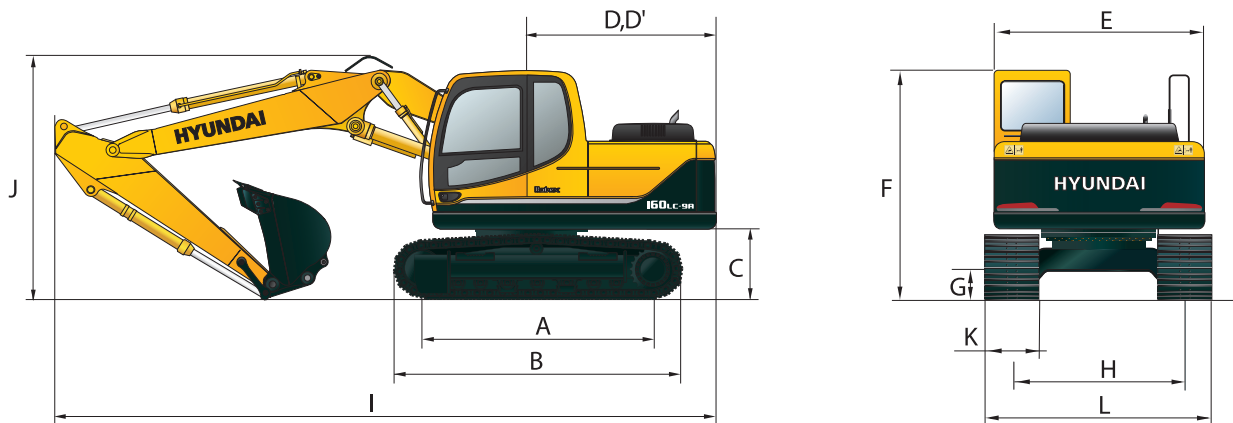

mm (ft-in)

mm (ft-in)

A Tumbler distance	3,170 (10' 5")	Boom length	5,100 (16' 9")	
B Overall length of crawler	3,960 (13' 0")	Arm length	2,200 (7' 3")	2,600 (8' 6")
C Ground clearance of counterweight	1,055 (3' 6")	I Overall length	8,610 (28' 3")	8,610 (28' 3")
D Tail swing radius	2,530 (8' 4")	J Overall height of boom	3,040 (9' 12")	3,060 (10' 0")
D' Rear-end length	2,480 (8' 2")	K Track shoe width	500 (20")	600 (24")
E Overall width of upperstructure	2,475 (8' 1")			700 (28")
F Overall height of cab	2,980 (9' 9")	L Overall width	2,490 (8' 2")	2,590 (8' 6")
G Min. ground clearance	460 (1' 6")			2,690 (8' 10")
H Track gauge	1,990 (6' 6")			

## R160LC-9A 2-PIECE BOOM WORKING RANGE

mm (ft-in)

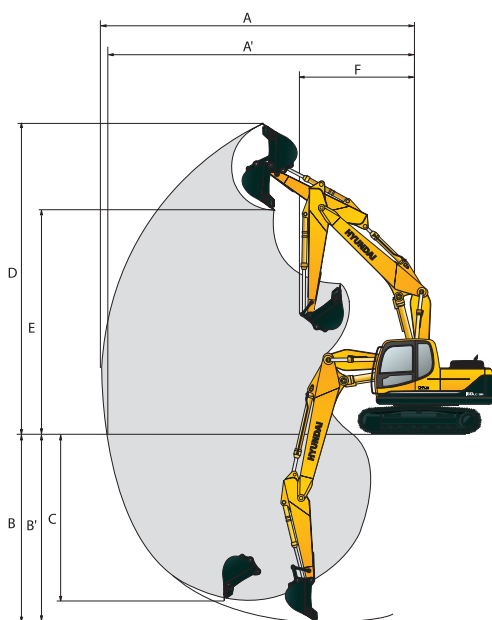

Boom length	5,100 (16' 9")	
Arm length	2,200 (7' 3")	2,600 (8' 6")
A Max. digging reach	8,760 (28' 9")	9,110 (29' 11")
A' Max. digging reach on ground	8,590 (28' 2")	8,950 (29' 4")
B Max. digging depth	5,430 (17' 10")	5,830 (19' 2")
B' Max. digging depth (8° level)	5,330 (17' 6")	5,730 (18' 10")
C Max. vertical wall digging depth	4,630 (15' 2")	4,980 (16' 4")
D Max. digging height	9,420 (30' 11")	9,610 (31' 6")
E Max. dumping height	6,710 (22' 0")	6,910 (22' 8")
F Min. swing radius	3,100 (10' 2")	2,970 (9' 9")

# Dimensions & Working Range

## R160LCD-9A DIMENSIONS

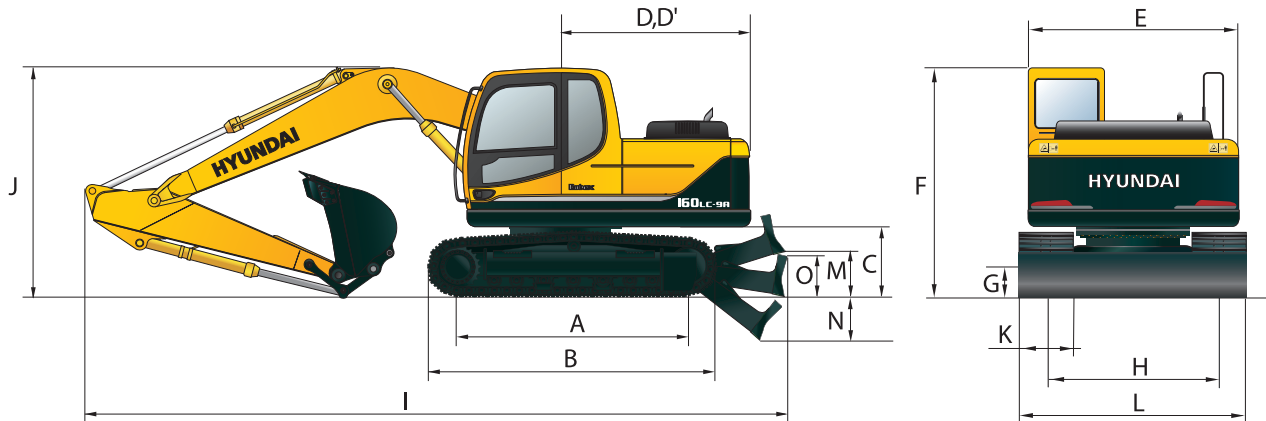

mm (ft-in)

mm (ft-in)

A Tumbler distance	3,170 (10' 5")	Boom length	5,100 (16' 9")		
B Overall length of crawler	3,960 (13' 0")	Arm length	2,200 (7' 3")	2,600 (8' 6")	3,100 (10' 2")
C Ground clearance of counterweight	1,055 (3' 6")	I Overall length	9,110 (29' 11")	9,100 (29' 10")	9,100 (29' 10")
D Tail swing radius	2,530 (8' 4")	J Overall height of boom	3,010 (9' 11")	2,990 (9' 10")	3,150 (10' 4")
D' Rear-end length	2,480 (8' 2")	K Track shoe width	500 (20")	600 (24")	700 (28")
E Overall width of upperstructure	2,475 (8' 1")	L Overall width	2,490 (8' 2")	2,590 (8' 6")	2,690 (8' 10")
F Overall height of cab	2,980 (9' 9")				
G Min. ground clearance	460 (1' 6")				
H Track gauge	1,990 (6' 6")				
M Ground clearance of blade up	615 (2' 0")				
N Depth of blade down	675 (2' 3")				
O Height of blade	640 (2' 1")				

## R160LCD-9A WORKING RANGE

mm (ft-in)

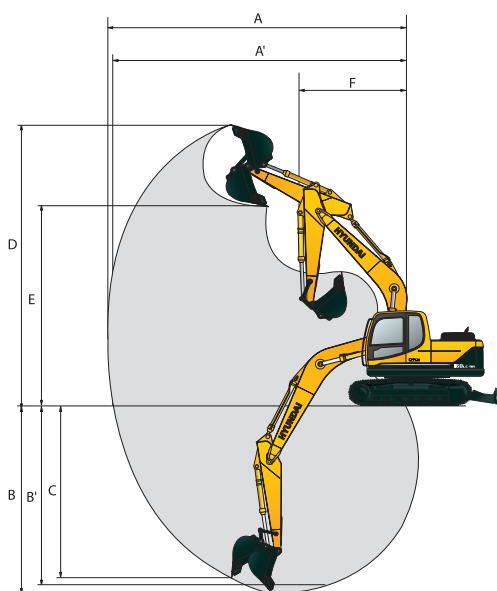

Boom length	5,100 (16' 9")		
Arm length	2,200 (7' 3")	2,600 (8' 6")	3,100 (10' 2")
A Max. digging reach	8,690 (28' 6")	9,020 (29' 7")	9,450 (31' 0")
A' Max. digging reach on ground	8,530 (27' 12")	8,860 (29' 1")	9,300 (30' 6")
B Max. digging depth	5,660 (18' 7")	6,060 (19' 11")	6,560 (21' 6")
B' Max. digging depth (8' level)	5,430 (17' 10")	5,850 (19' 2")	6,370 (20' 11")
C Max. vertical wall digging depth	5,120 (16' 10")	5,380 (17' 8")	5,710 (18' 9")
D Max. digging height	8,750 (28' 8")	8,840 (29' 0")	8,980 (29' 6")
E Max. dumping height	6,110 (20' 1")	6,220 (20' 5")	6,390 (21' 0")
F Min. swing radius	3,180 (10' 5")	3,170 (10' 5")	3,170 (10' 5")



# Dimensions & Working Range

## R160LCD-9A 2-PIECE BOOM DIMENSIONS

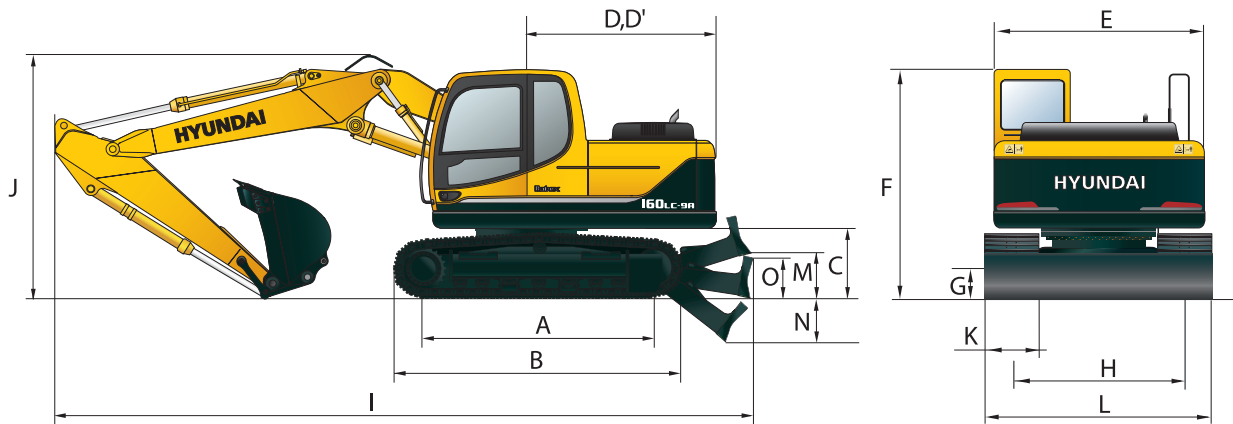

mm (ft-in)

mm (ft-in)

A	Tumbler distance	3,170 (10' 5")	Boom length			5,100 (16' 9")		
B	Overall length of crawler	3,960 (13' 0")	Arm length		2,200 (7' 3")	2,600 (8' 6")		
C	Ground clearance of counterweight	1,055 (3' 6")	I Overall length		9,080 (29' 9")		9,080 (29' 9")	
D	Tail swing radius	2,530 (8' 4")	J Overall height of boom		3,040 (9' 12")		3,060 (10' 0")	
D'	Rear-end length	2,480 (8' 2")	K Track shoe width		500 (20")	600 (24")	700 (28")	
E	Overall width of upperstructure	2,475 (8' 1")	L Overall width		2,490 (8' 2")	2,590 (8' 6")	2,690 (8' 10")	
F	Overall height of cab	2,980 (9' 9")						
G	Min. ground clearance	460 (1' 6")						
H	Track gauge	1,990 (6' 6")						
M	Ground clearance of blade up	615 (2' 0")						
N	Depth of blade down	675 (2' 3")						
O	Height of blade	640 (2' 1")						

## R160LCD-9A 2-PIECE BOOM WORKING RANGE

mm (ft-in)

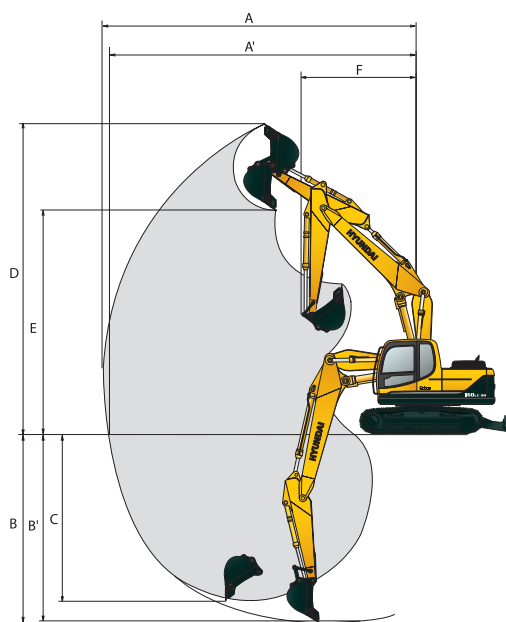











Boom length		5,100 (16' 9")	
Arm length		2,200 (7' 3")	2,600 (8' 6")
A	Max. digging reach	8,760 (28' 9")	9,110 (29' 11")
A'	Max. digging reach on ground	8,590 (28' 2")	8,950 (29' 4")
B	Max. digging depth	5,430 (17' 10")	5,830 (19' 2")
B'	Max. digging depth (8' level)	5,330 (17' 6")	5,730 (18' 10")
C	Max. vertical wall digging depth	4,630 (15' 2")	4,980 (16' 4")
D	Max. digging height	9,420 (30' 11")	9,610 (31' 6")
E	Max. dumping height	6,710 (22' 0")	6,910 (22' 8")
F	Min. swing radius	3,100 (10' 2")	2,970 (9' 9")

# Lifting Capacity













## R160LC-9A

 Rating over-front  Rating over-side or 360 degree













Boom : 5.10 m (16' 9") / Arm : 2.20 m (7' 3") / Bucket : 0.70 m<sup>3</sup> (0.92 yd<sup>3</sup>) SAE heaped / Shoe : 600mm (24") triple grouser

Load point height m (ft)	Load radius								At max. reach			
	1.5 m (5.0 ft)		3.0 m (10.0 ft)		4.5 m (15.0 ft)		6.0 m (20.0 ft)		Capacity		Reach m (ft)	
												
7.5 m (25.0 ft)	kg									*3770	3660	5.60
	lb									*8310	8070	(18.4)
6.0 m (20.0 ft)	kg									*3690	2460	6.98
	lb									*8140	5420	(22.9)
4.5 m (15.0 ft)	kg					*4590	*4590	*4130	3120	3240	1980	7.76
	lb					*10120	*10120	*9110	6880	7140	4370	(25.5)
3.0 m (10.0 ft)	kg		*9120	8860	*5810	4720	*4620	2990	2930	2930	1770	8.15
	lb		*20110	19530	*12810	10410	*10190	6590	6460	6460	3900	(26.7)
1.5 m (5.0 ft)	kg				*7050	4360	4680	2830	2850	2850	1700	8.20
	lb				*15540	9610	10320	6240	6280	6280	3750	(26.9)
Ground	kg		*7100	*7100	7170	4150	4550	2710	2980	2980	1770	7.94
	lb		*15650	*15650	15810	9150	10030	5970	6570	6570	3900	(26.0)
Line	kg											
-1.5 m (-5.0 ft)	kg	*7010	*7010	*11130	7780	7100	4090	4500	2670	3390	2030	7.31
	lb	*15450	*15450	*24540	17150	15650	9020	9920	5890	7470	4480	(24.0)
-3.0 m (-10.0 ft)	kg	*11210	*11210	*9650	7930	*6690	4150			*3780	2700	6.19
	lb	*24710	*24710	*21270	17480	*14750	9150			*8330	5950	(20.3)
-4.5 m (-15.0 ft)	kg			*6300	*6300							
	lb			*13890	*13890							

Boom : 5.10 m (16' 9") / Arm : 2.60 m (8' 6") / Bucket : 0.70 m<sup>3</sup> (0.92 yd<sup>3</sup>) SAE heaped / Shoe : 600mm (24") triple grouser

Load point height m (ft)	Load radius										At max. reach		
	1.5 m (5.0 ft)		3.0 m (10.0 ft)		4.5 m (15.0 ft)		6.0 m (20.0 ft)		7.5 m (25.0 ft)		Capacity		Reach m (ft)
													
7.5 m (25.0 ft)	kg										*3410	3190	6.11
	lb										*7520	7030	(20.0)
6.0 m (20.0 ft)	kg						*3040	*3040			*3380	2240	7.37
	lb						*6700	*6700			*7450	4940	(24.2)
4.5 m (15.0 ft)	kg						*3790	3150			3000	1820	8.11
	lb						*8360	6940			6610	4010	(26.6)
3.0 m (10.0 ft)	kg		*7930	*7930	*5330	4770	*4320	2990	*2830	2020	2730	1630	8.48
	lb		*17480	*17480	*11750	10520	*9520	6590	*6240	4450	6020	3590	(27.8)
1.5 m (5.0 ft)	kg		*8090	8060	*6680	4380	4670	2820	3250	1940	2650	1560	8.53
	lb		*17840	17770	*14730	9660	10300	6220	7170	4280	5840	3440	(28.0)
Ground	kg		*7880	7700	7150	4130	4520	2680	3190	1880	2750	1620	8.28
	lb		*17370	16980	15760	9110	9960	5910	7030	4140	6060	3570	(27.2)
Line	kg												
-1.5 m (-5.0 ft)	kg	*6690	*6690	*10670	7660	7030	4020	4440	2610		3090	1830	7.69
	lb	*14750	*14750	*23520	16890	15500	8860	9790	5750		6810	4030	(25.2)
-3.0 m (-10.0 ft)	kg	*9970	*9970	*10310	7780	*6990	4050	4470	2640		*3770	2350	6.64
	lb	*21980	*21980	*22730	17150	*15410	8930	9850	5820		*8310	5180	(21.8)
-4.5 m (-15.0 ft)	kg			*7500	*7500	*4980	4230						
	lb			*16530	*16530	*10980	9330						

Boom : 5.10 m (16' 9") / Arm : 3.10 m (11' 1") / Bucket : 0.70 m<sup>3</sup> (0.92 yd<sup>3</sup>) SAE heaped / Shoe : 600mm(24") triple grouser

Load point height m (ft)	Load radius										At max. reach			
	1.5 m (5.0 ft)		3.0 m (10.0 ft)		4.5 m (15.0 ft)		6.0 m (20.0 ft)		7.5 m (25.0 ft)		Capacity		Reach m (ft)	
														
7.5 m (25.0 ft)	kg										*3030	2700	6.73	
	lb										*6680	5950	(22.1)	
6.0 m (20.0 ft)	kg						*2890	*2890			*3050	1980	7.88	
	lb						*6370	*6370			*6720	4370	(25.9)	
4.5 m (15.0 ft)	kg						*3370	3180	*2150	2080	2720	1630	8.57	
	lb						*7430	7010	*4740	4590	6000	3590	(28.1)	
3.0 m (10.0 ft)	kg				*4730	*4730	*3950	3010	*3110	2020	2490	1460	8.91	
	lb				*10430	*10430	*8710	6640	*6860	4450	5490	3220	(29.2)	
1.5 m (5.0 ft)	kg		*10240	8300	*6180	4430	*4640	2820	3240	1920	2420	1400	8.96	
	lb		*22580	18300	*13620	9770	*10230	6220	7140	4230	5340	3090	(29.4)	
Ground	kg		*8650	7710	7150	4120	4500	2660	3150	1840	2490	1440	8.73	
	lb		*19070	17000	15760	9080	9920	5860	6940	4060	5490	3170	(28.6)	
Line	kg													
-1.5 m (-5.0 ft)	kg	*6290	*6290	*10300	7570	6980	3970	4390	2560	3110	1800	1600	8.17	
	lb	*13870	*13870	*22710	16690	15390	8750	9680	5640	6860	3970	6080	3530	(26.8)
-3.0 m (-10.0 ft)	kg	*8930	*8930	*10930	7630	6960	3960	4380	2550		3390	2000	7.21	
	lb	*19690	*19690	*24100	16820	15340	8730	9660	5620		7470	4410	(23.7)	
-4.5 m (-15.0 ft)	kg	*12410	*12410	*8670	7850	*5820	4070				*3390	3110	5.59	
	lb	*27360	*27360	*19110	17310	*12830	8970				*7470	6860	(18.3)	













- Lifting capacity is based on SAE J1097, ISO 10567.
- Lifting capacity of the Robex Series does not exceed 75% of the tipping load with the machine on firm, level ground or 87% of full hydraulic capacity.
- The load point is a hook located on the back of the bucket.
- (\*) indicates the load limited by hydraulic capacity.

# Lifting Capacity













## R160LC-9A 2-PIECE BOOM

 Rating over-front  Rating over-side or 360 degree

Boom : 5.10 m (16' 9") / Arm : 2.20 m (7' 3") / Bucket : 0.70 m<sup>3</sup> (0.92 yd<sup>3</sup>) SAE heaped / Shoe : 600mm (24") triple grouser

Load point height m (ft)	Load radius										At max. reach				
	1.5 m (5.0 ft)		3.0 m (10.0 ft)		4.5 m (15.0 ft)		6.0 m (20.0 ft)		7.5 m (25.0 ft)		Capacity		Reach		
													m (ft)		
6.0 m (20.0 ft)	kg														
	lb														
4.5 m (15.0 ft)	kg							*4170	3120				*3750	2390	7.06
	lb							*9190	6880				*8270	5270	(23.2)
3.0 m (10.0 ft)	kg					*5860	4710	*4630	2970				2890	1710	8.21
	lb					*12920	10380	*10210	6550				6370	3770	(26.9)
1.5 m (5.0 ft)	kg					*7010	4330	4700	2800	3270	1930		2820	1650	8.27
	lb					*15450	9550	10360	6170	7210	4250		6220	3640	(27.1)
Ground	kg			*6200	*6200	7180	4100	4560	2680				2950	1730	8.01
Line	lb			*13670	*13670	15830	9040	10050	5910				6500	3810	(26.3)
-1.5 m (-5.0 ft)	kg	*6200	*6200	*10330	7710	7110	4040	4510	2640				3360	1990	7.39
	lb	*13670	*13670	*22770	17000	15670	8910	9940	5820				7410	4390	(24.2)
-3.0 m (-10.0 ft)	kg			*9150	7900	*6410	4120						*3300	2650	6.28
	lb			*20170	17420	*14130	9080						*7280	5840	(20.6)

Boom : 5.10 m (16' 9") / Arm : 2.60 m (8' 6") / Bucket : 0.70 m<sup>3</sup> (0.92 yd<sup>3</sup>) SAE heaped / Shoe : 600mm (24") triple grouser

Load point height m (ft)	Load radius										At max. reach				
	1.5 m (5.0 ft)		3.0 m (10.0 ft)		4.5 m (15.0 ft)		6.0 m (20.0 ft)		7.5 m (25.0 ft)		Capacity		Reach		
													m (ft)		
6.0 m (20.0 ft)	kg														
	lb														
4.5 m (15.0 ft)	kg														
	lb														
3.0 m (10.0 ft)	kg							*4350	2980	*3250	2000		2680	1570	8.57
	lb							*9590	6570	*7170	4410		5910	3460	(28.1)
1.5 m (5.0 ft)	kg			*6980	*6980	*6660	4350	4690	2790	3260	1920		2610	1510	8.62
	lb			*15390	*15390	*14680	9590	10340	6150	7190	4230		5750	3330	(28.3)
Ground	kg			*7040	*7040	7160	4080	4530	2650	3190	1850		2710	1570	8.37
Line	lb			*15520	*15520	15790	8990	9990	5840	7030	4080		5970	3460	(27.5)
-1.5 m (-5.0 ft)	kg	*6030	*6030	*9960	7580	7040	3970	4450	2580				3050	1780	7.78
	lb	*13290	*13290	*21960	16710	15520	8750	9810	5690				6720	3920	(25.5)
-3.0 m (-10.0 ft)	kg	*9490	*9490	*9860	7730	*6740	4010	4490	2610				*3350	2290	6.76
	lb	*20920	*20920	*21740	17040	*14860	8840	9900	5750				*7390	5050	(22.2)
-4.5 m (-15.0 ft)	kg			*6840	*6840	*4560	4220								
	lb			*15080	*15080	*10050	9300								











- Lifting capacity is based on SAE J1097, ISO 10567.
- Lifting capacity of the Robex Series does not exceed 75% of the tipping load with the machine on firm, level ground or 87% of full hydraulic capacity.
- The load point is a hook located on the back of the bucket.
- (\*) indicates the load limited by hydraulic capacity.

# Lifting Capacity













## R160LCD-9A

 Rating over-front  Rating over-side or 360 degree













Boom : 5.10 m (16' 9") / Arm : 2.20 m (7' 3") / Bucket : 0.70 m<sup>3</sup> (0.92 yd<sup>3</sup>) SAE heaped / Shoe : 600mm (24") triple grouser

Load point height m (ft)	Load radius								At max. reach		Reach m (ft)	
	1.5 m (5.0 ft)		3.0 m (10.0 ft)		4.5 m (15.0 ft)		6.0 m (20.0 ft)		Capacity			
												
7.5 m (25.0 ft)	kg									*3770	*3770	5.60
	lb									*8310	*8310	(18.4)
6.0 m (20.0 ft)	kg									*3690	2600	6.98
	lb									*8140	5730	(22.9)
4.5 m (15.0 ft)	kg					*4590	*4590	*4130	3290	3590	2110	7.76
	lb					*10120	*10120	*9110	7250	7910	4650	(25.5)
3.0 m (10.0 ft)	kg			*9120	*9120	*5810	4950	*4620	3150	3260	1880	8.15
	lb			*20110	*20110	*12810	10910	*10190	6940	7190	4140	(26.7)
1.5 m (5.0 ft)	kg					*7050	4600	5170	2990	3180	1810	8.20
	lb					*15540	10140	11400	6590	7010	3990	(26.9)
Ground	kg			*7100	*7100	*7710	4390	5040	2880	3320	1890	7.94
	lb			*15650	*15650	*17000	9680	11110	6350	7320	4170	(26.0)
Line	kg											
	lb											
-1.5 m (-5.0 ft)	kg	*7010	*7010	*11130	8200	*7620	4320	4990	2620	3770	2160	7.31
	lb	*15450	*15450	*24540	18080	*16800	9520	11000	5810	8310	4760	(24.0)
-3.0 m (-10.0 ft)	kg	*11210	*11210	*9650	8360	*6690	4380			*3780	2860	6.19
	lb	*24710	*24710	*21270	18430	*14750	9660			*8330	6310	(20.3)
-4.5 m (-15.0 ft)	kg			*6300	*6300							
	lb			*13890	*13890							

Boom : 5.10 m (16' 9") / Arm : 2.60 m (8' 6") / Bucket : 0.70 m<sup>3</sup> (0.92 yd<sup>3</sup>) SAE heaped / Shoe : 600mm (24") triple grouser

Load point height m (ft)	Load radius										At max. reach		Reach m (ft)	
	1.5 m (5.0 ft)		3.0 m (10.0 ft)		4.5 m (15.0 ft)		6.0 m (20.0 ft)		7.5 m (25.0 ft)		Capacity			
														
7.5 m (25.0 ft)	kg											*3410	3350	6.11
	lb											*7520	7390	(20.0)
6.0 m (20.0 ft)	kg							*3040	*3040			*3380	2370	7.37
	lb							*6700	*6700			*7450	5220	(24.2)
4.5 m (15.0 ft)	kg							*3790	3310			3340	1940	8.11
	lb							*8360	7300			7360	4280	(26.6)
3.0 m (10.0 ft)	kg			*7930	*7930	*5330	5000	*4320	3160	*2830	2140	3040	1730	8.48
	lb			*17480	*17480	*11750	11020	*9520	6970	*6240	4720	6700	3810	(27.8)
1.5 m (5.0 ft)	kg			*8090	*8090	*6680	4620	*4950	2980	3620	2070	2960	1670	8.53
	lb			*17840	*17840	*14730	10190	*10910	6570	7980	4560	6530	3680	(28.0)
Ground	kg			*7880	*7880	*7520	4360	5010	2840	*3490	2010	3080	1730	8.28
	lb			*17370	*17370	*16580	9610	11050	6260	*7690	4430	6790	3810	(27.2)
Line	kg													
	lb													
-1.5 m (-5.0 ft)	kg	*6690	*6690	*10670	8080	*7650	4260	4930	2780			3450	1950	7.69
	lb	*14750	*14750	*23520	17810	*16870	9390	10870	6130			7610	4300	(25.2)
-3.0 m (-10.0 ft)	kg	*9970	*9970	*10310	8200	*6990	4280	*4900	2800			*3770	2500	6.64
	lb	*21980	*21980	*22730	18080	*15410	9440	*10800	6170			*8310	5510	(21.8)
-4.5 m (-15.0 ft)	kg			*7500	*7500	*4980	4460							
	lb			*16530	*16530	*10980	9830							

Boom : 5.10 m (16' 9") / Arm : 3.10 m (11' 1") / Bucket : 0.70 m<sup>3</sup> (0.92 yd<sup>3</sup>) SAE heaped / Shoe : 600mm (24") triple grouser

Load point height m (ft)	Load radius										At max. reach		Reach m (ft)	
	1.5 m (5.0 ft)		3.0 m (10.0 ft)		4.5 m (15.0 ft)		6.0 m (20.0 ft)		7.5 m (25.0 ft)		Capacity			
														
7.5 m (25.0 ft)	kg											*3030	2850	6.73
	lb											*6680	6280	(22.1)
6.0 m (20.0 ft)	kg							*2890	*2890			*3050	2090	7.88
	lb							*6370	*6370			*6720	4610	(25.9)
4.5 m (15.0 ft)	kg							*3370	3340	*2150	*2150	3040	1740	8.57
	lb							*7430	7360	*4740	*4740	6700	3840	(28.1)
3.0 m (10.0 ft)	kg					*4730	*4730	*3950	3180	*3110	2140	2790	1560	8.91
	lb					*10430	*10430	*8710	7010	*6860	4720	6150	3440	(29.2)
1.5 m (5.0 ft)	kg			*10240	8720	*6180	4670	*4640	2980	3610	2050	2710	1500	8.96
	lb			*22580	19220	*13620	10300	*10230	6570	7960	4520	5970	3310	(29.4)
Ground	kg			*8650	8130	*7240	4360	4990	2820	3520	1970	2800	1540	8.73
	lb			*19070	17920	*15960	9610	11000	6220	7760	4340	6170	3400	(28.6)
Line	kg													
	lb													
-1.5 m (-5.0 ft)	kg	*6290	*6290	*10300	7990	*7610	4210	4880	2730	*3250	1930	3090	1720	8.17
	lb	*13870	*13870	*22710	17610	*16780	9280	10760	6020	*7170	4250	6810	3790	(26.8)
-3.0 m (-10.0 ft)	kg	*8930	*8930	*10930	8050	*7230	4190	4870	2710			*3660	2130	7.21
	lb	*19690	*19690	*24100	17750	*15940	9240	10740	5970			*8070	4700	(23.7)
-4.5 m (-15.0 ft)	kg	*12410	*12410	*8670	8270	*5820	4310					*3390	3290	5.59
	lb	*27360	*27360	*19110	18230	*12830	9500					*7470	7250	(18.3)













- Lifting capacity is based on SAE J1097, ISO 10567.
- Lifting capacity of the Robex Series does not exceed 75% of the tipping load with the machine on firm, level ground or 87% of full hydraulic capacity.
- The load point is a hook located on the back of the bucket.
- (\*) indicates the load limited by hydraulic capacity.

# Lifting Capacity













## R160LCD-9A 2-PIECE BOOM

 Rating over-front  Rating over-side or 360 degree

Boom : 5.10 m (16' 9") / Arm : 2.20 m (7' 3") / Bucket : 0.70 m<sup>3</sup> (0.92 yd<sup>3</sup>) SAE heaped / Shoe : 600mm (24") triple grouser

Load point height m (ft)	Load radius										At max. reach			
	1.5 m (5.0 ft)		3.0 m (10.0 ft)		4.5 m (15.0 ft)		6.0 m (20.0 ft)		7.5 m (25.0 ft)		Capacity		Reach	
													m (ft)	
6.0 m (20.0 ft)	kg											*3750	2520	7.06
	lb											*8270	5560	(23.2)
4.5 m (15.0 ft)	kg						*4170	3280				3540	2040	7.83
	lb						*9190	7230				7800	4500	(25.7)
3.0 m (10.0 ft)	kg				*5860	4950	*4630	3130				3220	1830	8.21
	lb				*12920	10910	*10210	6900				7100	4030	(26.9)
1.5 m (5.0 ft)	kg				*7010	4560	*5140	2970	*3450	2060		3140	1760	8.27
	lb				*15450	10050	*11330	6550	*7610	4540		6920	3880	(27.1)
Ground	kg		*6200	*6200	*7590	4340	5050	2840				3290	1840	8.01
	lb		*13670	*13670	*16730	9570	11130	6260				7250	4060	(26.3)
-1.5 m (-5.0 ft)	kg	*6200	*6200	*10330	8130	*7430	4280	5000	2800			*3710	2120	7.39
	lb	*13670	*13670	*22770	17920	*16380	9440	11020	6170			*8180	4670	(24.2)
-3.0 m (-10.0 ft)	kg			*9150	8320	*6410	4350					*3300	2800	6.28
	lb			*20170	18340	*14130	9590					*7280	6170	(20.6)

Boom : 5.10 m (16' 9") / Arm : 2.60 m (8' 6") / Bucket : 0.70 m<sup>3</sup> (0.92 yd<sup>3</sup>) SAE heaped / Shoe : 600mm (24") triple grouser

Load point height m (ft)	Load radius										At max. reach			
	1.5 m (5.0 ft)		3.0 m (10.0 ft)		4.5 m (15.0 ft)		6.0 m (20.0 ft)		7.5 m (25.0 ft)		Capacity		Reach	
													m (ft)	
6.0 m (20.0 ft)	kg											*3450	2280	7.48
	lb											*7610	5030	(24.5)
4.5 m (15.0 ft)	kg											3280	1870	8.20
	lb											7230	4120	(26.9)
3.0 m (10.0 ft)	kg						*4350	3150	*3250	2120		2990	1680	8.57
	lb						*9590	6940	*7170	4670		6590	3700	(28.1)
1.5 m (5.0 ft)	kg			*6980	*6980	*6660	4590	*4920	2960	3630	2040	2920	1620	8.62
	lb			*15390	*15390	*14680	10120	*10850	6530	8000	4500	6440	3570	(28.3)
Ground	kg			*7040	*7040	*7420	4310	5020	2810	3560	1980	3030	1680	8.37
	lb			*15520	*15520	*16360	9500	11070	6190	7850	4370	6680	3700	(27.5)
-1.5 m (-5.0 ft)	kg	*6030	*6030	*9960	8010	*7480	4210	4940	2740			3400	1900	7.78
	lb	*13290	*13290	*21960	17660	*16490	9280	10890	6040			7500	4190	(25.5)
-3.0 m (-10.0 ft)	kg	*9490	*9490	*9860	8150	*6740	4250	*4700	2780			*3350	2430	6.76
	lb	*20920	*20920	*21740	17970	*14860	9370	*10360	6130			*7390	5360	(22.2)
-4.5 m (-15.0 ft)	kg			*6840	*6840	*4560	4460							
	lb			*15080	*15080	*10050	9830							

- Lifting capacity is based on SAE J1097, ISO 10567.
- Lifting capacity of the Robex Series does not exceed 75% of the tipping load with the machine on firm, level ground or 87% of full hydraulic capacity.
- The load point is a hook located on the back of the bucket.
- (\*) indicates the load limited by hydraulic capacity.

# Notes

# Notes

## STANDARD EQUIPMENT

ISO Standard cabin
All-weather steel cab with 360° visibility
Safety glass windows
Rise-up type windshield wiper
Sliding side window (LH)
Lockable door
Hot & cool box
Storage compartment & Ashtray
Transparent cabin roof-cover
Radio / USB Player
12 volt power outlet (24V DC to 12V DC converter)
Handsfree mobile phone system with USB
Sun visor
Computer aided power optimization (New CAPO) system
3-power mode, 2-work mode, User mode
Auto deceleration & one-touch deceleration system
Auto warm-up system
Auto overheat prevention system
Automatic climate control
Air conditioner & heater
Defroster
Self-diagnostics system
Starting Aid (air grid heater) for cold weather
Centralized monitoring
LCD display
Engine speed or Trip meter/Accel.
Clock
Gauges
Fuel level gauge
Engine coolant temperature gauge
Hyd. oil temperature gauge
Warnings
Check Engine
Overload
Communication error
Low battery
Air cleaner clogging
Indicators
Max power
Low speed/High speed
Fuel warmer
Auto idle
Door and cab locks, one key
Three outside rearview mirrors
Fully adjustable suspension seat with seat belt
Pilot-operated slidable joystick
Console box height adjust system
Four front working lights
Electric horn
Batteries (2 x 12V x 100 AH)
Battery master switch
Removable clean-out dust net for cooler
Automatic swing brake
Removable reservoir tank
Fuel pre-filter with fuel warmer
Boom holding system
Arm holding system
Track shoes (600mm, 24")
Track rail guard
Accumulator for lowering work equipment
Electric transducer
Lower frame under cover (Normal)

## OPTIONAL EQUIPMENT

Fuel filler pump (35 L/min)
Beacon lamp
Safety lock valve for boom cylinder with overload warning device
Safety lock valve for arm cylinder
Single-acting piping kit (breaker, etc.)
Double-acting piping kit (clamshell, etc.)
Quick coupler
Travel alarm
Booms
5.1m, 16' 9"
5.1m, 16' 9" (Hydraulic adjustable boom)
Arms
2.2m, 7' 3"
2.6m, 8' 6"
3.1m, 10' 2"
Cabin FOPS/FOG (ISO/DIS 10262-Level II)
FOPS (Falling Object Protective Structure)
FOG (Falling Object Guard)
Cabin ROPS (ISO 12117-2)
ROPS (Roll-over Protective Structure)
Cabin Guard front
Wire net
Fine net
Cabin roof-steel cover
Cabin lights
Cabin front window rain guard
Track shoes
Triple grousers shoe (500mm, 20")
Triple grousers shoe (700mm, 28")
R160LCD-9A Blade : 640mm (2' 1") x 2,490mm (8' 2")
640mm (2' 1") x 2,590mm (8' 6")
Lower frame under cover(Additional)
Tool kit
Rearview camera
Seat
Adjustable air suspension seat with heater
Pattern change valve (2 patterns)
Hi-mate (Remote Management System)

- \* Standard and optional equipment may vary. Contact your Hyundai dealer for more information. The machine may vary according to international standards.
- \* The photos may include attachments and optional equipment that are not available in your area.
- \* Materials and specifications are subject to change without advance notice.
- \* All imperial measurements rounded off to the nearest pound or inch.

PLEASE CONTACT



6100 Atlantic Blvd, Norcross, GA 30071  
 TEL (678) 823-7777 FAX (678) 823-7778