

We build a better future

Robex 60CR-9A

With Tier 4 Final Engine Installed



*Photo may include optional equipment.

Pride at Work

Hyundai Heavy Industries strives to build state-of-the-art earthmoving equipment to give every operator maximum performance, more precision, versatile machine preferences, and proven quality. Take pride in your work with Hyundai!



Robex 60CR-9A

Machine Walk-Around



*Photo may include optional equipment.

Rugged Upper and Lower Frame

The upper frame is designed with optimum structural integrity to absorb impact and operational stress. The x-style center frame and reinforced box section track frame provide exceptional strength and longer service life to withstand tough working conditions.

Engine Technology

The fuel efficient, Tier 4 final certified Yanmar 4TNV98 engine provides proven, reliable power. This engine is electronically controlled for optimum fuel to air ratio and clean, efficient combustion and provides low noise, anti-restart features.

Efficient Control System

All control devices are arranged for higher productivity and improved operator comfort. Efficient and ergonomic controls allow an operator to control the machine in any working environment. A safety lever on the left-side console is provided to prevent exiting the cabin while hydraulic controls are live.

Advanced Hydraulic System

The R60CR-9A's advanced hydraulic system includes an arm flow summation system, boom holding system and a swing parking brake for smooth and fine control. Other valuable features include a hydraulic damper in the travel pedal, and a hydraulically lubricated swing reducer with a leak-free grease chamber.

Comfortable and Durable Cabin

The cabin is roomy and ergonomically designed, for reduced noise and good visibility. The cabin frame meets international standard TOPS, ROPS, FOPS ensuring operator safety.

Operator Convenience

Convenient operator features include a suspension seat, excellent visibility, and variable storage space for advanced operator comfort. The newly designed LED cluster provides current information, including engine RPM, engine coolant, fuel level, and electric components. A hydraulic function safety lock and auto diagnostic features are also available. Lock and failure diagnosis functions are also integrated. A powerful air conditioning system and Radio & USB player contribute to a productive work environment.

Easy and Simple Maintenance

Wide open access of doors, covers, hoods is designed for easier maintenance. The air cleaner and centralized grease fittings are also integrated for easy service.

Extended Life of Components

Long life components and wear parts, including hydraulic filters, oil, shims and bushings, help to reduce operating costs.

Preference

The powerful and sophisticated R60CR-9A provides the operator with a large, comfortable operating environment and an ergonomically designed suspension seat with arm rests for an enhanced operating experience. For additional convenience, precision designed joystick controllers and an easy to read monitor provide the operator with quick access to information and machine control.



*Photo may include optional equipment.



Wide Cabin with Excellent Visibility

The newly designed cabin was conceived for more space, a wider field of view and operator comfort. Special attention was given to a clear, open and convenient interior with plenty of visibility on the machine surroundings and the job at hand. This well balanced combination of precision aspects put the operator in the perfect position to work safely and securely.

Operator Comfort

The R60CR-9A operator's cab is designed for a comfortable operating experience. An ergonomically designed suspension seat, adjustable arm rests and a spacious environment helps to minimize operator fatigue. Control levers are easily accessible and a instrument display is provided to keep the operator informed of pertinent machine information.

1. A large upper roof glass provides additional visibility and a roller shade is provided to reduce glare and sunlight.
2. An advanced audio system with AM/FM stereo with USB player input, plus remotely located control is perfect for listening to music favorites.
3. A blue-tooth hands-free cell phone function is available for safe and convenient phone use.
4. Ergonomically designed joysticks reduce operator fatigue during the work day.
5. Accel dial with LED lamp is easy to control and recognizable in darkness.
6. Multiple storage compartments are available for additional convenience.

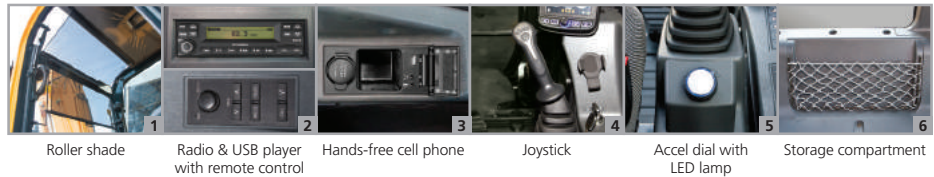

Enhanced Cabin

Hyundai's R60CR-9A is equipped for convenience and productivity.

1. Adjustable position window prevents window movement while operating.
2. A sliding fold-in front window is easily opened and safely stored in an open position to improve ventilation and visibility.
3. A tilt-up left side control console provides easier entrance and exit from the cab.
4. A full auto air-conditioning system provides the operator with optimum air temperature.



Operator - Friendly Cluster

The advanced new LED cluster allows the operator to select his personal machine preferences. The monitor displays engine rpm, engine oil temperature, water temperature and information for all electronic devices.

Button selections are provided for auto idle mode, max power mode, and travel speed. A security feature is also provided to prevent the machine from starting without a proper password.

Precision & Performance

Innovative hydraulic system technologies make the R60CR-9A excavator fast, smooth and easy to control. Also R60CR-9A is designed for maximum performance to keep the operator working productively.



*Photo may include optional equipment.

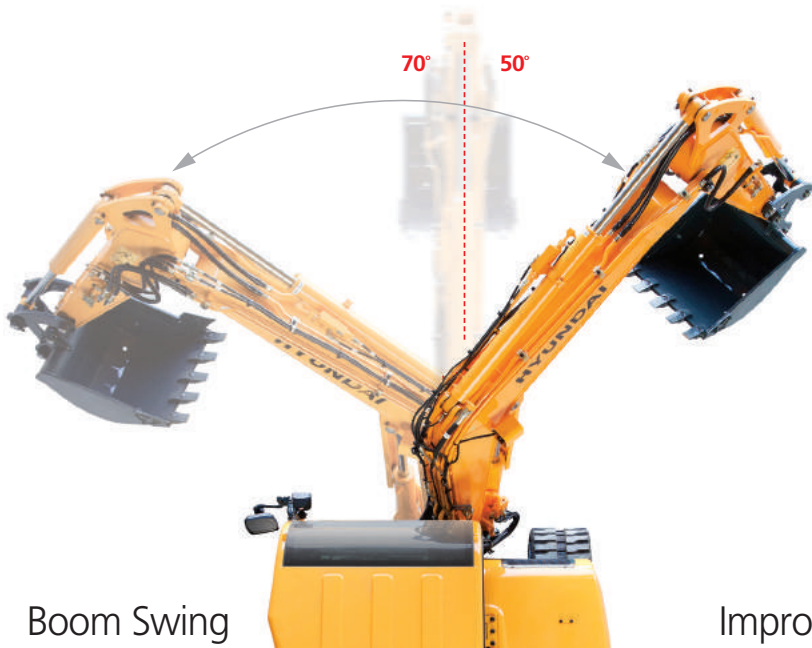

Boom Swing

The R60CR-9A's boom swing function is designed for efficient work in congested residential and urban areas. The boom can be offset left or right within an operating range. Plus, increased swing torque provides enhanced operating capability on the slope.

Improved Hydraulic System

Optimized matching between the joystick and main control valve improves fine control and smoothness of operation. An arm flow summation system provides energy savings, reduced cavitation and increased speed. To improve safety and avoid boom drift the R60CR-9A is equipped with an integrated boom holding system.

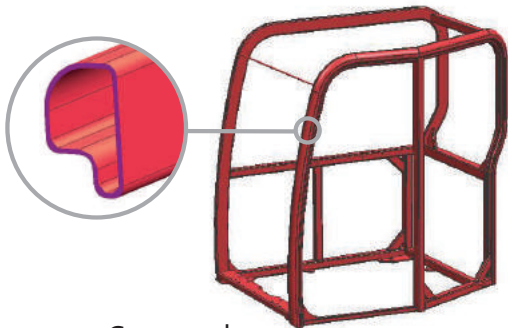

Structure Strength

The R60CR-9A cabin structure has been fitted with stronger but slimmer tubing for added safety and improved visibility. Low-stress, high strength steel is integrally welded to form a stronger, more durable upper and lower frame. Structural integrity was tested by way of FEM (Finite Elements Method) analysis and long-term durability tests.



Short Tail Swing

R60CR-9A's short tail swing radius allows the operator work in confined areas like close to buildings on roadways, and in urban areas. This compact radius design provides easy and efficient operation in any limited space work environment.



Yanmar 4TNV98C

The Highest Engine Power in its Class

Yanmar 4TNV98C engine provides 24 kgf.m (174 lbf.ft) of maximum torque with 57 HP at 2,200rpm of rated power. This means the R60CR-9A runs with the most power in its class, giving you more power to get the job done.

Profitability

R60CR-9A is designed to maximize profitability through improved efficiencies, enhanced service features and longer life components.



*Photo may include optional equipment.

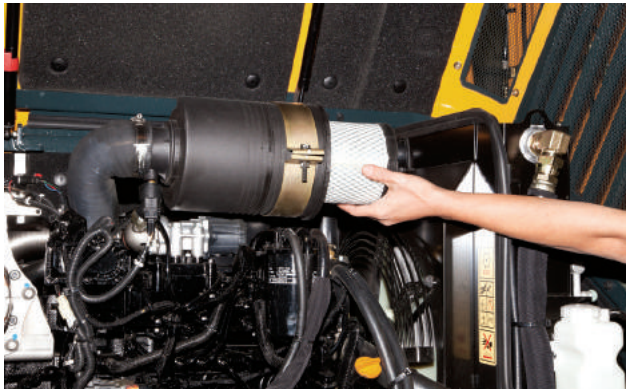

Easy Change Air Cleaner

The R60CR-9A is equipped with a durable plastic air cleaner designed for easy maintenance.



Wide Open Engine hood

A newly designed full-open type engine hood makes service more convenient on the R60CR-9A.

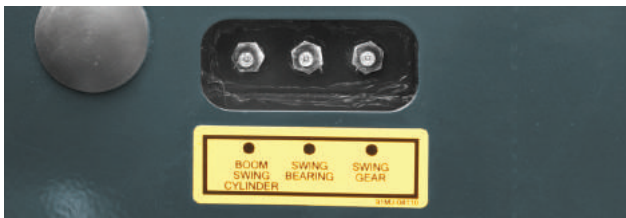

Centralized Grease Fittings

A centralized lubrication bank is available for faster, easier service and maintenance.



Improved Durability

The R60CR-9A's boom cylinder & dozer cylinder cover provide added protection on the tough working condition.



Tilting Cabin

R60CR-9A's tiltable cabin provides the operator with convenient maintenance.



Long-Life Components

9A series excavators were designed with bushings designed for long-life lube intervals (250hrs) & polymer shims (wear resistant, noise reducing), long-life hydraulic filters (1,000hrs), long-life hydraulic oil (5,000hrs), more efficient cooling systems and integrated preheating systems which extend service intervals, minimize operating costs and reduce machine down time.

Specifications

ENGINE

MODEL		YANMAR 4TNV98C	
Type		Water cooled, 4 cycle diesel 4 cylinders in line, direct injection, low emission	
Rated flywheel horsepower	SAE	J1995 (gross)	64.7 HP (48.3 kW) at 2,200 rpm
		J1349 (net)	63 HP (47.0 kW) at 2,200 rpm
	DIN	6271/1 (gross)	65.6 PS (48.3 kW) at 2,200 rpm
		6271/1 (net)	63.9 PS (47.0 kW) at 2,200 rpm
Max. torque		24 kgf-m (174 lbf-ft) at 1,560 rpm	
Bore X stroke		98 mm (3.86") x 110 mm (4.33")	
Piston displacement		3,319 cc (203 cu in)	
Batteries		1 x 12 V x 100 AH	
Starting motor		12V-3.0 kW	
Alternator		12V-80 Amp	

HYDRAULIC SYSTEM

MAIN PUMP	
Type	Variable displacement piston pumps
Max. flow	2 X 57.8 ℓ/min(15.3 US gpm/12.7 UK gpm)pumps
Sub-pump for pilot circuit	Gear pump
Cross-sensing and fuel saving pump system	

HYDRAULIC MOTORS	
Travel	Two speed axial piston motor with counter balance valve and parking brake
Swing	Axial piston motor with automatic brake

RELIEF VALVE SETTING	
Implement circuits	220 kgf/cm ² (3,130 psi)
Travel circuit	220 kgf/cm ² (3,130 psi)
Swing circuit	220 kgf/cm ² (3,130 psi)
Pilot circuit	30 kgf/cm ² (430 psi)
Service valve	Installed

HYDRAULIC CYLINDERS	
No. of cylinder bore X stroke	Boom: 1-110 x 715 mm (4.3" x 28.1")
	Arm: 1-85 x 840 mm (3.3" x 33.1")
	Bucket: 1-80 x 660 mm (3.1" x 26.0")
	Boom swing: 1-95 x 519 mm (3.7" x 20.4")
	Dozer blade: 1-110 x 224 mm (4.3" x 8.8")

NOISE LEVEL (CAB)

Nosie levels (dynamic valve)	
LwA	97 dB
LpA	76 dB

TRAVEL SYSTEM

Drive method	Full hydrostatic type
Drive motor	Axial piston motor, in-shoe design
Reduction system	Planetary reduction gear
Max. drawbar pull	5,300 kgf (11,700 lbf)
Max. travel speed(high) / (low)	4.0 km/hr (2.5 mph) / 2.2 km/hr (1.4 mph)
Gradeability	35° (70%)
Parking brake	Multi-wet disc

CONTROLS

Pilot pressure operated joysticks and pedals with detachable lever provide almost effortless and fatigueless operation.

Pilot control	Two joysticks with one safety lever (LH): Arm swing, Boom swing (RH): Boom and bucket (ISO)
Traveling and steering	Two levers with pedals
Engine throttle	Electric, Dial type

SWING SYSTEM

Swing motor	Axial piston motor
Swing reduction	Planetary gear reduction
Swing bearing lubrication	Grease-bathed
Swing brake	Multi wet disc
Swing speed	8.8 rpm

COOLANT & LUBRICANT CAPACITY

(Refilling)	liter	US gal	UK gal
Fuel tank	125.0	33.0	27.5
Engine coolant	11.0	2.9	2.4
Engine oil	11.6	3.1	2.6
Final drive(each)	1.2	0.3	0.3
Hydraulic tank	70.0	18.5	15.4
Hydraulic system	120.0	31.7	26.4

UNDERCARRIAGE

X-leg type center frame is integrally welded with reinforced box-section track frames. The undercarriage includes lubricate rollers, track adjusters with shock absorbing springs and sprockets, and track chain with triple grouser shoes.

Center frame	X - leg type
Track frame	Pentagonal box type
No. of track shoe on each side	40
No. of upper roller on each side	1
No. of lower roller on each side	5

OPERATING WEIGHT (APPROXIMATE)

Operating weight, including 2,900 mm (9' 6") boom, 1,480 mm (4' 10") arm, SAE heaped 0.18 m³ (0.24 yd³) digging bucket, lubricant, coolant, full fuel tank, hydraulic tank and the standard equipment.

MAJOR COMPONENT WEIGHT	
Upperstructure	2,900 kg (6,390 lb)
Mono boom (with arm cylinder)	310 kg (680 lb)

OPERATING WEIGHT		
Operating weight	Steel track (380mm)	5,900 kg (13,010 lb)
	Rubber track	5,800 kg (12,790 lb)
	Steel track (450mm)	5,960 kg (13,140 lb)
Ground Pressure	Steel track (380mm)	0.36 kgf-m / cm ² (5.12 psi)
	Rubber track	0.34 kgf-m / cm ² (4.83 psi)
	Steel track (450mm)	0.31 kgf-m / cm ² (4.41 psi)

BUCKETS

Capacity		Width		Weight
SAE heaped	CECE heaped	Without side cutters	With side cutters	
0.07 m ³ (0.09 yd ³)	0.06 m ³ (0.08 yd ³)	315 mm (12.4")	360 mm (14.2")	115 kg (255 lb)
0.18 m ³ (0.24 yd ³)	0.15 m ³ (0.20 yd ³)	670 mm (26.4")	740 mm (29.1")	170 kg (375 lb)

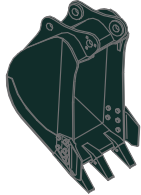

SAE heaped

0.07 m³ (0.09 yd³)

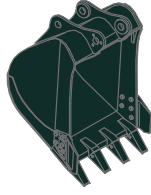

0.18 m³ (0.24 yd³)

DIGGING FORCE (ISO)

	1.48m Arm	1.9m Arm
Bucket	4,170 kgf	4,170 kgf
	40.9 kN	40.9 kN
	9,190 lbf	9,190 lbf
Arm	2,700 kgf	2,280 kgf
	26.5 kN	22.4 kN
	5,950 lbf	5,030 lbf

Lifting Capacity

R60CR-9A

Rating over-front Rating over-side or 360 degree

Boom : 2.9m (9' 6") / Arm : 1.48 m (4' 10") / Bucket : 0.18m³ (0.24yd³) SAE heaped / Dozer blade down

Load point height m (ft)		Load radius								At max. reach		
		2.0 m (7 ft)		3.0 m (10 ft)		4.0 m (13 ft)		5.0 m (16 ft)		Capacity		Reach m (ft)
4.0 m (13 ft)	kg lb					*1120 *2470	*1120 *2470			*1050 *2310	790 1740	4.99 (16.4)
3.0 m (10 ft)	kg lb					*1180 *2600	1130 2490			*1080 *2380	640 1410	5.56 (18.2)
2.0 m (7 ft)	kg lb			*1890 *4170	1710 3770	*1430 *3150	1080 2380	*1250 *2760	740 1630	*1120 *2470	580 1280	5.82 (19.1)
1.0 m (3 ft)	kg lb			*2670 *5890	1580 3480	*1740 *3840	1020 2250	*1360 *3000	720 1590	*1160 *2560	560 1230	5.84 (19.2)
Ground Line	kg lb	*1980 *4370	*1980 *4370	*3000 *6610	1520 3350	*1930 *4250	980 2160	*1430 *3150	700 1540	*1190 *2620	590 1300	5.61 (18.4)
-1.0 m (-3 ft)	kg lb	*3230 *7120	3030 6680	*2890 *6370	1500 3310	*1910 *4210	970 2140			*1210 *2670	690 1520	5.09 (16.7)
-2.0 m (-7 ft)	kg lb	*3960 *8730	3080 6790	*2370 *5220	1530 3370					*1110 *2450	990 2180	4.12 (13.5)

- Lifting capacity is based on SAE J1097, ISO 10567.
- Lifting capacity of the Robex Series does not exceed 75% of the tipping load with the machine on firm, level ground or 87% of full hydraulic capacity.
- The load point is a hook located on the back of the bucket.
- (*) indicates the load limited by hydraulic capacity.

Dimensions & Working Range

R60CR-9A DIMENSIONS

unit: mm(ft · in)

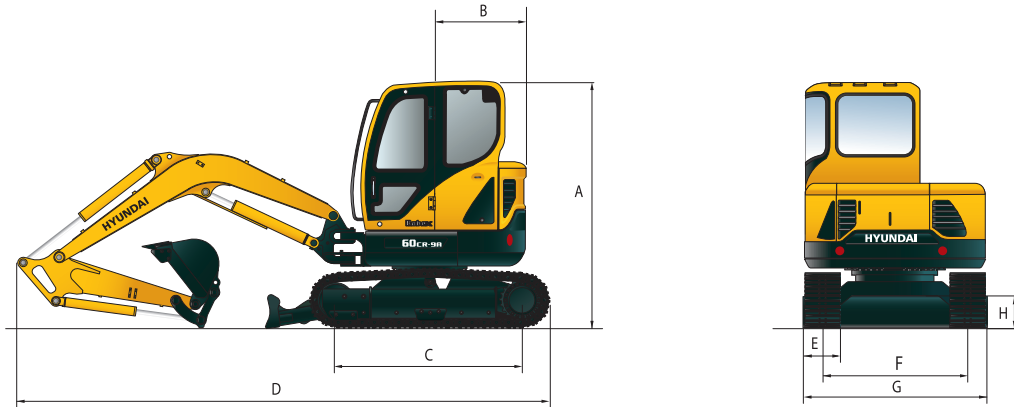

		mm (ft·in)	
A	Overall height of cab	2,550 (8' 4")	
B	Tail swing radius	1,080 (3' 7")	
C	Tumbler distance	1,990 (6' 6")	
D	Overall length	5,600 (18' 4")	
E	Track shoe width	Steel	380 (1' 3")
		Rubber	400 (1' 4")
F	Track gauge		1,600 (5' 3")
G	Overall width		2,000 (6' 7")
H	Ground clearance		380 (1' 3")

R60CR-9A WORKING RANGE

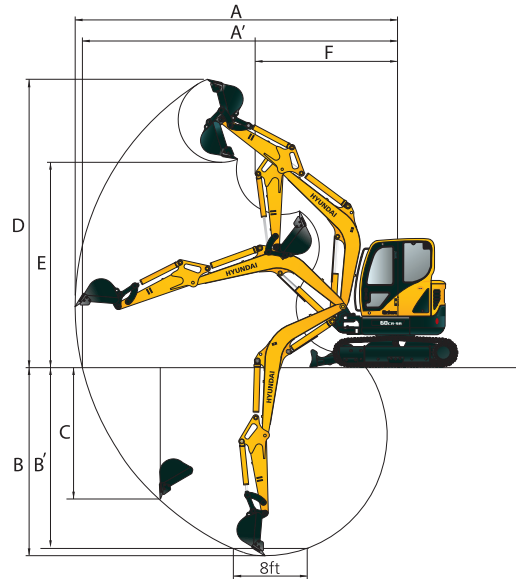

unit: mm(ft · in)











Boom length	2,900 (9' 6")	
Arm length	1,480 (4' 10")	1,900 (6' 3")
A Max. digging reach	6,150 (20' 2")	6,480 (21' 3")
A' Max. digging reach on ground	6,010 (19' 9")	6,350 (20' 10")
B Max. digging depth	3,570 (11' 9")	3,990 (13' 1")
B' Max. digging depth (8 ft)	3,160 (10' 5")	3,620 (11' 11")
C Max. vertical wall digging depth	3,040 (9' 12")	3,360 (11' 0")
D Max. digging height	5,680 (18' 8")	5,850 (19' 2")
E Max. dumping height	3,930 (12' 11")	4,100 (13' 5")
F Min. swing radius	2,420 (7' 11")	2,510 (8' 3")

Lifting Capacity











R60CR-9A

 Rating over-front  Rating over-side or 360 degree











Boom : 2.9m (9' 6") / Arm : 1.48 m (4' 10") / Bucket : 0.18m³ (0.24yd³) SAE heaped / Dozer blade up

Load point height m (ft)		Load radius								At max. reach		
		2.0 m (7 ft)		3.0 m (10 ft)		4.0 m (13 ft)		5.0 m (16 ft)		Capacity		Reach m (ft)
												
4.0 m (13 ft)	kg lb					*1120 *2470	1070 2360			1040 2290	740 1630	4.99 (16.4)
3.0 m (10 ft)	kg lb					*1180 *2600	1060 2340			860 1900	600 1320	5.56 (18.2)
2.0 m (7 ft)	kg lb			*1890 *4170	1600 3530	1430 3150	1010 2230	990 2180	690 1520	780 1720	540 1190	5.82 (19.1)
1.0 m (3 ft)	kg lb			2150 4740	1470 3240	1370 3020	960 2120	970 2140	670 1480	770 1700	520 1150	5.84 (19.2)
Ground Line	kg lb	*1980 *4370	*1980 *4370	2080 4590	1410 3110	1330 2930	920 2030	950 2090	650 1430	810 1790	550 1210	5.61 (18.4)
-1.0 m (-3 ft)	kg lb	*3230 *7120	2770 6110	2070 4560	1400 3090	1320 2910	900 1980			940 2070	650 1430	5.09 (16.7)
-2.0 m (-7 ft)	kg lb	*3960 *8730	2820 6220	2090 4610	1420 3130					*1110 *2450	920 2030	4.12 (13.5)

Boom : 2.9m (9' 6") / Arm : 1.90 m (6' 3") / Bucket : 0.18m³ (0.24yd³) SAE heaped / Dozer blade down

Load point height m (ft)		Load radius								At max. reach		
		2.0 m (7 ft)		3.0 m (10 ft)		4.0 m (13 ft)		5.0 m (16 ft)		Capacity		Reach m (ft)
												
4.0 m (13 ft)	kg lb									*900 *1980	670 1480	5.45 (17.9)
3.0 m (10 ft)	kg lb					*950 *2090	*950 *2090	*950 *2090	750 1650	*940 *2070	550 1210	5.96 (19.6)
2.0 m (7 ft)	kg lb			*1470 *3240	*1470 *3240	*1220 *2690	1070 2360	*1100 *2430	730 1610	*980 *2160	500 1100	6.19 (20.3)
1.0 m (3 ft)	kg lb			*2330 *5140	1580 3480	*1560 *3440	1010 2230	*1250 *2760	700 1540	*1020 *2250	490 1080	6.21 (20.4)
Ground Line	kg lb	*2000 *4410	*2000 *4410	*2850 *6280	1480 3260	*1820 *4010	950 2090	*1360 *3000	670 1480	*1070 *2360	510 1120	6.00 (19.7)
-1.0 m (-3 ft)	kg lb	*2840 *6260	*2840 *6260	*2920 *6440	1450 3200	*1900 *4190	930 2050	*1360 *3000	660 1460	*1110 *2450	580 1280	5.54 (18.2)
-2.0 m (-7 ft)	kg lb	*3980 *8770	2950 6500	*2590 *5710	1460 3220	*1690 *3730	930 2050			*1100 *2430	760 1680	4.70 (15.4)

Boom : 2.9m (9' 6") / Arm : 1.90 m (6' 3") / Bucket : 0.18m³ (0.24yd³) SAE heaped / Dozer blade up

Load point height m (ft)		Load radius								At max. reach		
		2.0 m (7 ft)		3.0 m (10 ft)		4.0 m (13 ft)		5.0 m (16 ft)		Capacity		Reach m (ft)
												
4.0 m (13 ft)	kg lb									890 1960	620 1370	5.45 (17.9)
3.0 m (10 ft)	kg lb					*950 *2090	*950 *2090	*950 *2090	700 1540	750 1650	510 1120	5.96 (19.6)
2.0 m (7 ft)	kg lb			*1470 *3240	*1470 *3240	*1220 *2690	1000 2200	980 2160	680 1500	690 1520	460 1010	6.19 (20.3)
1.0 m (3 ft)	kg lb			2150 4740	1470 3240	1360 3000	940 2070	950 2090	650 1430	670 1480	450 990	6.21 (20.4)
Ground Line	kg lb	*2000 *4410	*2000 *4410	2040 4500	1370 3020	1300 2870	880 1940	920 2030	620 1370	700 1540	470 1040	6.00 (19.7)
-1.0 m (-3 ft)	kg lb	*2840 *6260	2660 5860	2010 4430	1340 2950	1270 2800	860 1900	910 2010	610 1340	790 1740	530 1170	5.54 (18.2)
-2.0 m (-7 ft)	kg lb	*3980 *8770	2700 5950	2020 4450	1350 2980	1280 2820	860 1900			1040 2290	710 1570	4.70 (15.4)

- Lifting capacity is based on SAE J1097, ISO 10567.
- Lifting capacity of the Robex Series does not exceed 75% of the tipping load with the machine on firm, level ground or 87% of full hydraulic capacity.
- The load point is a hook located on the back of the bucket.
- (*) indicates the load limited by hydraulic capacity.

Notes

Notes

STANDARD EQUIPMENT

ISO standard cabin

- Cabin ROPS(ISO 12117-2)
 - FOPS(ISO 3449)
 - FOG(ISO 10262 Level I)
 - TOPS(ISO 12117)
- All-weather steel cab with all-around visibility
- Safety glass windows
- Rise-up type windshield wiper
- Sliding fold-in front window
- Sliding side window
- Lockable door
- Accessory box & Ash-tray

Centralized monitoring

- Engine speed
- Gauges
 - Fuel level gauge
 - Engine coolant temperature gauge
- Warning
 - Fuel level
 - Engine oil pressure
 - Engine coolant temperature
 - Hyd. oil temperature
 - Low battery
 - Air cleaner clogging
- Fuel prefilter

Air-conditioner & heater

Single acting piping kit (breaker, etc)

Door and cab locks, one key

Radio / USB player with remote control

Outside rear view mirror

Fully adjustable suspension seat with seat belt

Console box tilting system(LH.)

Two front working lights

Electric horn

Battery (1 x 12 V x 100 AH)

Battery master switch

12 volt power supply

Automatic swing brake

Removable reservoir tank

Water separator, fuel line

Mono boom (2.9 m, 9' 6")

Arm (1.48 m, 4' 10")

Steel track shoes (380 mm, 1' 3")

Track rail guard

Starting aid (air grid heater) cold weather

OPTIONAL EQUIPMENT

Fuel filler pump (35ℓ/min, 9.2 US gpm)

Beacon lamp

Double acting piping kit (clamshell, etc)

Accumulator, work equipment lowering

Electric transducer

Travel alarm

Quick coupler

Rubber track (400mm, 1' 4")

Long arm (1.9m, 6'3")

Tool kit

Cabin rear work lamp

Lever pattern change valve

Additional CWT (200kg, 440lb)

Road liner

- Safety lock v/v for boom cylinder with overload warning
- Safety lock v/v for arm cylinder

Steel track and steel track with rubber pads (400mm)

Steel track (450mm)

Rubber shoes (400mm)

- Road liner

* Standard and optional equipment may vary. Contact your Hyundai dealer for more information. The machine may vary according to International standards.

* The photos may include attachments and optional equipment that are not available in your area.

* Materials and specifications are subject to change without advance notice.

* All imperial measurements rounded off to the nearest pound or inch.

PLEASE CONTACT



6100 Atlantic Blvd Norcross, GA 30071
TEL (678) 823 7777 FAX (678) 823 7778